

**Electronic Balance  
BA045 & BA058**

Impact Test Equipment Ltd  
[www.impact-test.co.uk](http://www.impact-test.co.uk) & [www.impact-test.com](http://www.impact-test.com)

User Guide  
**User Guide**  
**User Guide**

**Impact Test Equipment Ltd.  
Building 21 Stevenston Ind. Est.  
Stevenston  
Ayrshire  
KA20 3LR**

T: 01294 602626

F: 01294 461168

E: [sales@impact-test.co.uk](mailto:sales@impact-test.co.uk)

Test Equipment Web Site

[www.impact-test.co.uk](http://www.impact-test.co.uk)

Test Sieves & Accessories Web Site

[www.impact-test.com](http://www.impact-test.com)

---

---

Version 1.3 03/2004  
**Operating Instructions**  
Electronic Precision Balance

---

---

**Table of contents:**

<b>1</b>	<b>TECHNICAL DATA.....</b>	<b>52</b>
<b>2</b>	<b>CONTROL COMPONENTS .....</b>	<b>53</b>
2.1	BRIEF DESCRIPTION OF DISPLAY .....	54
2.2	KEYBOARD DESCRIPTION .....	55
2.3	IMPORTANT NOTICES .....	56
2.3.1	<i>Ambient conditions</i> .....	56
2.3.2	<i>Operating instructions for the balance</i> .....	57
2.4	BALANCE INSTALLATION.....	57
2.4.1	<i>Prepare the weighing chamber</i> .....	57
2.4.2	<i>Power connection</i> .....	58
2.4.3	<i>Connection of electrical components (peripherals)</i> .....	58
2.4.4	<i>Levelling the balance with the level</i> .....	58
2.5	STARTING THE BALANCE .....	59
2.5.1	<i>Warm-up time</i> .....	59
2.5.2	<i>On and off (standby mode)</i> .....	59
2.5.3	<i>Auto-check</i> .....	59
2.5.4	<i>Taring</i> .....	60
2.5.5	<i>Simple weighing (weight measurement)</i> .....	60
2.5.6	<i>Unit change-over</i> .....	60
2.6	DATA INTERFACE.....	60
2.7	CARE AND MAINTENANCE .....	61
2.7.1	<i>Cleaning</i> .....	61
2.7.2	<i>Safety check</i> .....	61
<b>3</b>	<b>DECLARATION OF CONFORMITY.....</b>	<b>62</b>
<b>4</b>	<b>OPERATING MENU OF THE BALANCE .....</b>	<b>65</b>
4.1	MODIFYING THE SETTINGS .....	65
4.2	SETTING MODIFICATIONS .....	65
4.3	MENU CALL .....	66
4.4	OPERATING MENU SUMMARY.....	67
4.4.1	<i>Selection of main menu</i> .....	67
4.4.2	<i>Menu indicator for FUnC.SEL menu option</i> .....	68
4.4.3	<i>Menu indicator for Unit.SEL menu option</i> .....	69
4.4.4	<i>Menu indicator for SETTInG menu option</i> .....	71
4.4.5	<i>Menu indicator for intFACE menu option</i> .....	72
4.4.6	<i>Menu indicator for iF :USEr menu option</i> .....	73
<b>5</b>	<b>ADJUSTMENT .....</b>	<b>74</b>
5.1	ADJUSTMENT WITH EXTERNAL WEIGHT .....	74
5.2	CHECKING THE BALANCE WITH THE INTERNAL WEIGHT .....	75
5.3	CHECKING THE BALANCE WITH THE EXTERNAL WEIGHT .....	75
5.4	CHECKING THE BALANCE WITH THE INTERNAL WEIGHT .....	75

<b>6</b>	<b>APPLICATION PROGRAMS.....</b>	<b>77</b>
6.1	AUTO-ZERO FUNCTION .....	77
6.2	FILTER .....	77
6.3	STANDBY RANGE .....	78
6.4	CHANGING THE UNITS .....	79
6.5	PERCENTAGE WEIGHING .....	80
6.6	COUNTING .....	81
6.7	AUTO-PRINT DISPLAY .....	82
6.8	CAPACITY INDICATOR (ANALOG DISPLAY) .....	83
6.9	SELECTING THE ADJUSTMENT TYPE .....	84
6.10	ADJUSTING THE ADJUSTMENT WEIGHT .....	85
6.11	SETTING THE ID NUMBER.....	86
6.12	SETTING THE DATE .....	87
6.13	SETTING THE TIME .....	88
6.13.1	<i>Entering seconds</i> .....	88
6.13.2	<i>Setting hours and minutes</i> .....	89
6.14	PRINTING OFF DATE AND TIME .....	90
<b>7</b>	<b>DESCRIPTION OF INTERFACES .....</b>	<b>91</b>
7.1	GENERAL INSTRUCTIONS .....	91
7.2	GENERAL DATA .....	91
7.3	EXAMPLE FOR CABLE WIRING: .....	91
7.4	FORMATTING INPUT AND OUTPUT DATA .....	92
7.5	ENTERING COMMANDS.....	93
<b>8</b>	<b>TROUBLESHOOTING .....</b>	<b>94</b>
8.1	ERROR DISPLAY .....	95
<b>9</b>	<b>IMPORTANT INFORMATION .....</b>	<b>96</b>

Please read the operating instructions carefully before starting to work with the balance.

After unpacking, check that the apparatus has no visible external damage.

Keep all packing materials for future transport. Unplug all connected cables prior to shipping to prevent any unnecessary damage.

# 1 Technical data

<b>Model</b>		<b>BA045</b>	<b>BA058</b>
<i>Readout (d)</i>		0,1 mg	0,1 mg
<i>Verification value (e)</i>		1 mg	1 mg
<i>Weighing range (Max)</i>		120g	220 g
<i>Min. load (Min)</i>		0,01 g	0,01g
<i>Reproducibility</i>	0,1 mg		
<i>Linearity</i>	± 0,2 mg		
<i>Response time</i>	3 sec.		
<i>Response time</i>	intern		
<i>Operating temperature</i>	+ 5° .... + 40° C		
<i>Electric power supply</i>	12 VDC		
<i>Weighing plate spezial steel</i>	Ø 80 mm		
<i>Case (W x D x H) mm</i>	217 x 305 x 320		
<i>Weight net (aprox.)</i>	7 kg		

## 2 control components

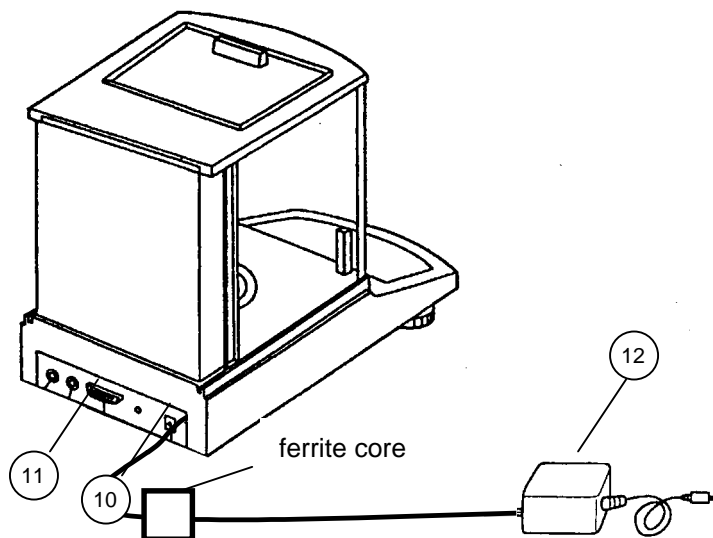
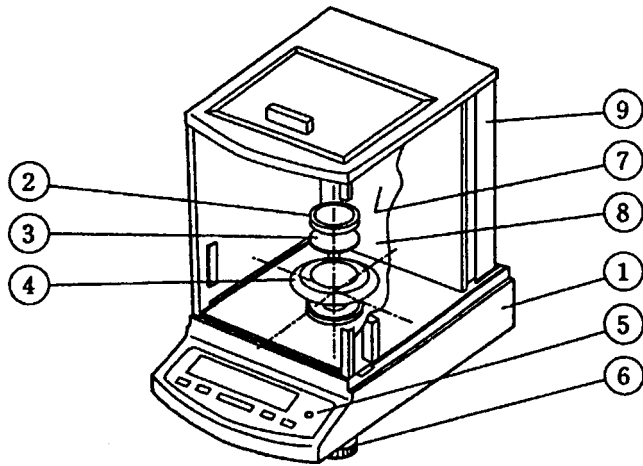

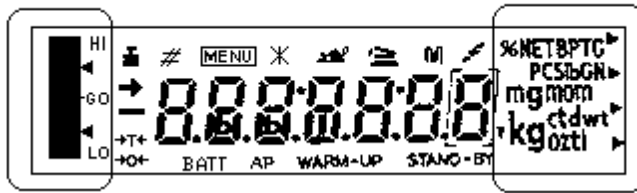

Pos.	Description	Pos.	Description
1	Balance housing	7	Glass doors
2	Weighing plate	8	Weighing chamber
3	Weighing plate holder	9	Rear wall of balance
4	Protective ring	10	Connection for voltage adapter
5	Level	11	RS232 C data interface
6	Support foot	12	AC power supply
			Adjustment weight N/A for these models

## 2.1 Brief description of display





Analog display

Weight unit display

Display	Description
→	Standby indicator Lights if the weight measurement is stable.
	Weight indicator Lights during calibration Also lights on the BA045/050 models when calibration needs to be carried out.
	Menu indicator When the menu is called up, the display is activated.
	Communication display Lights when an RS-232C or DATA I/O connection has been established
<b>AP</b>	Auto-print display Lights when Auto-Print is ON
STAND-BY	Standby indicator Lights when the balance is in standby mode

## 2.2 Keyboard description

Key	During weighing		During menu selection	
	Pressed briefly	Pressed for 3 sec	Pressed briefly	Pressed for 3 sec
ON/OFF/ESC	Toggles balance to standby or cancels function e.g., (E CAL)	—	Returns to previous menu	Returns to weighing mode
CAL MENU		In part and percentage mode: selection menu for part and %	Selects function values within function	—
TARE 	Tares or zeros of weight display	—	Selects function or scrolls one menu option toward right in menu	—
UNIT 	Toggles of weight units (must be set up in operation menu of balance)		Increases numeric value for selected figure	—
PRINT 	Outputs weight at external device (printer) or PC	—	Selects figure to be modified	—



## **2.3 Important notices**

### **2.3.1 Ambient conditions**

The items of equipment are constructed to provide reliable weighing results under normal ambient conditions in a functioning laboratory. A suitable location for the balance will make it easier to obtain fast, reliable results with the balance.

The following steps must be taken when siting the balance:

Place the balance on a flat, stable surface;

Prevent extreme heat due to placement near a heat source or direct sunlight;

- Protect the balance from direct air currents due to open doors or windows;
- Prevent strong vibrations during weighing;
- Protect the balance from harsh chemical vapours;
- Do not use the balance in areas where there is any risk of explosion.

Do not expose the apparatus to high humidity for extended periods of time. Dew (condensation due to moisture in the apparatus) may result when transferring the apparatus from a cold area to a noticeably warmer environment. In this case, acclimatise the apparatus to the ambient temperature for about 2 hours.

Avoid magnetic and electric fields around the balance.

Check the balance with the verification weights at least once a day.

The warranty is voided if the balance is opened.

### **2.3.2 Operating instructions for the balance**

Remove the product from the weighing plate after weighing it.

Do not force the balance to open.

Do not allow the balance to come into contact with water or metal shavings.

If the balance is not used for an extended period of time (7 days), unplug the power supply.

Do not weigh magnetic objects.

Do not exert any pressure on the weighing plate.

## **2.4 Balance installation**

Remove the adhesive sheeting, adhesive strips and foam material.

### **2.4.1 Prepare the weighing chamber.**

Place the following parts on the balance in sequential order:

- Protective ring (4)
- Plate holder (3)
- Plate (2)

## 2.4.2 Power connection

The balance is powered by an external power supply. The voltage printed on the device must match the local mains voltage.

### **Note!**

Use only original power supplies. The use of other brands, even if authorised by official agents, must be approved by a specialist.

### **Plug the balance into the power outlet.**

Turn on the power supply at the mains voltage.  
Make sure there are no objects on the weighing plate.

The balance will work through a check procedure and carry out calibration using a fitted calibration weight.

The "oFF" message will appear on the display.

The balance will then be in standby mode. Press the "ON/OFF" key to turn on the balance.

## 2.4.3 Connection of electrical components (peripherals)

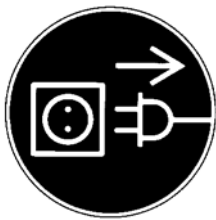

Unplug the balance from the power outlet before connecting or removing additional devices (printer, PC) from the data interface.

## 2.4.4 Levelling the balance with the level

Use the support screws to level the balance until it is horizontal and the air bubble is inside the red circle.

## 2.5 Starting the balance

### 2.5.1 Warm-up time

In order for the balance to provide accurate results, the device must be warmed up for at least 4 hours after being plugged for the first time or after an extended power outage. After this time, the balance will have reached the necessary operating temperature.

### 2.5.2 On and off (standby mode)

To turn the display on and off, use the **ON/OFF/ESC** key.

### 2.5.3 Auto-check

An automatic function test of the balance electronics is carried out after switching on from standby mode. At the end of the test, the display will indicate zero. The balance is now ready to be used.

The following symbols will appear in the display window of the balance for information purposes:

oFF

The balance is in **OFF mode**.

The balance is not plugged into the power mains.  
(New connection, power outage above 1 second)

Standby

The balance is in **standby mode**.

The display was turned off by pressing the **ON/OFF/ESC** key and is now available. The balance is ready to run when turned on and does not require a warm-up period. In addition, the time is displayed in standby mode.

CHE 5

The CHE display appears after the power is turned on.

The balance will work through a check procedure (5, 4, 3, 2, 1) and then switch to **OFF** mode.

## 2.5.4 Taring

Accurate weighing is only possible if the display indicated 0.0000 g before the objects were weighed. Press the **TARE/**  key to zero the weight display. Taring can be done over the entire weight range of the balance.

## 2.5.5 Simple weighing (weight measurement)

Place the item to be weighed on the plate. Read the weight when the  standby symbol appears on the display.

## 2.5.6 Unit change-over

The units set in the balance operation menu can be called up by pressing the **UNIT/**  key.

## 2.6 Data interface

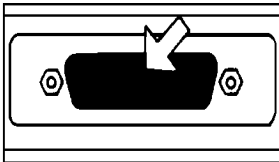

The interface connection is located at the rear of the balance.

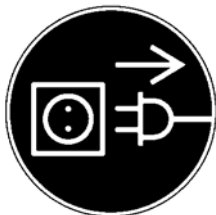

### Note!

Unplug the balance from the power outlet before connecting or removing additional devices (printer, PC) from the data interface.

To output data, press the **PRINT/**  key.

Refer to the "Description of interface" chapter for more information on the data interface.

## 2.7 Care and maintenance

### 2.7.1 Cleaning

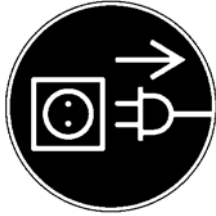

Always unplug the device from the power outlet before cleaning the apparatus.

Do not use harsh cleaning products (solvents or similar)! Use a damp cloth, moistened with a mild soapy solution. Make sure no moisture enters the apparatus, wiping with a soft, dry towel.

Remove any test residue/dust with care by using a fine paintbrush or hand vacuum cleaner.

### 2.7.2 Safety check

If risk-free service is no longer guaranteed, you must place the apparatus out of service by unplugging it from the power outlet and protecting from further use.

Risk-free service of the power supply is no longer guaranteed in the following cases.

- If the power supply is obviously damaged
- If the power supply no longer works
- After extended storage under adverse conditions.

In such cases, you must contact the supplier.

Any repairs must be performed by specialised technicians with access to the necessary repair documentation and instructions.

**Page intentionally left blank**

**Not applicable for BA045 and BA058**

### 3 Declaration of Conformity

**Declaration of conformity for apparatus with CE mark**  
**Konformitätserklärung für Geräte mit CE-Zeichen**  
**Déclaration de conformité pour appareils portant la marque CE**  
**Declaración de conformidad para aparatos con disitintivo CE**  
**Dichiarazione di cofnromità per apparecchi contrassegnati con la marcatura CE**

- English** We hereby declare that the product to which this declaration refers conforms with the following standards. Please consider the chapter Calibration information in the user manual  
**This declaration is only valid with the certificate of conformity by a notified body.**
- Deutsch** Wir erklären hiermit, daß das Produkt, auf das sich diese Erklärung bezieht, mit den nachstehenden Normen übereinstimmt. Unbedingt Kapitel Hinweise zur Eichung in der Bed.-Anleitung beachten.  
**Diese Erklärung gilt nur in Verbindung mit der Konformitätsbescheinigung einer benannten Stelle.**
- Français** Nous déclarons avec cela responsabilité que le produit, auquel se rapporte la présente déclaration, est conforme aux normes citées ci-après. Veuillez prendre en considération le chapitre Indication concernant l'étalonnage dans le mode d'emploi.  
**Cette déclaration est valide seulement avec un certificat de conformité d'un organisme notifié.**
- Español** Manifestamos en la presente que el producto al que se refiere esta declaración está de acuerdo con las normas siguientes. Le rogamos de considerar el capítulo Indicación para la calibración en el manual.  
**Esta declaración solo será válida acompañada del certificado de conformidad de conformidad de la parte nominal.**
- Italiano** Dichiariamo con ciò che il prodotto al quale la presente dichiarazione si riferisce è conforme alle norme di seguito citate. In ogni caso rispettare gli indicazioni quanto riguarda l'omologazione nel manuale di uso della bilancia  
**Questa dichiarazione sarà valida solo se accompagnata dal certificato di conformità della parte nominale.**

<b>Model:</b>	<b>BA045</b>
	<b>BA058</b>

<b>EU Directive</b>	<b>Standards</b>	<b>EC-type-approval certificate no.</b>	<b>Issued by</b>
90/384/EEC	EN 45501	T 5939	NMI

Date: 13.11.2001

Signature:





## Calibration information (BA045 BA058 only)

A security mark must be attached in compliance with the following drawing.

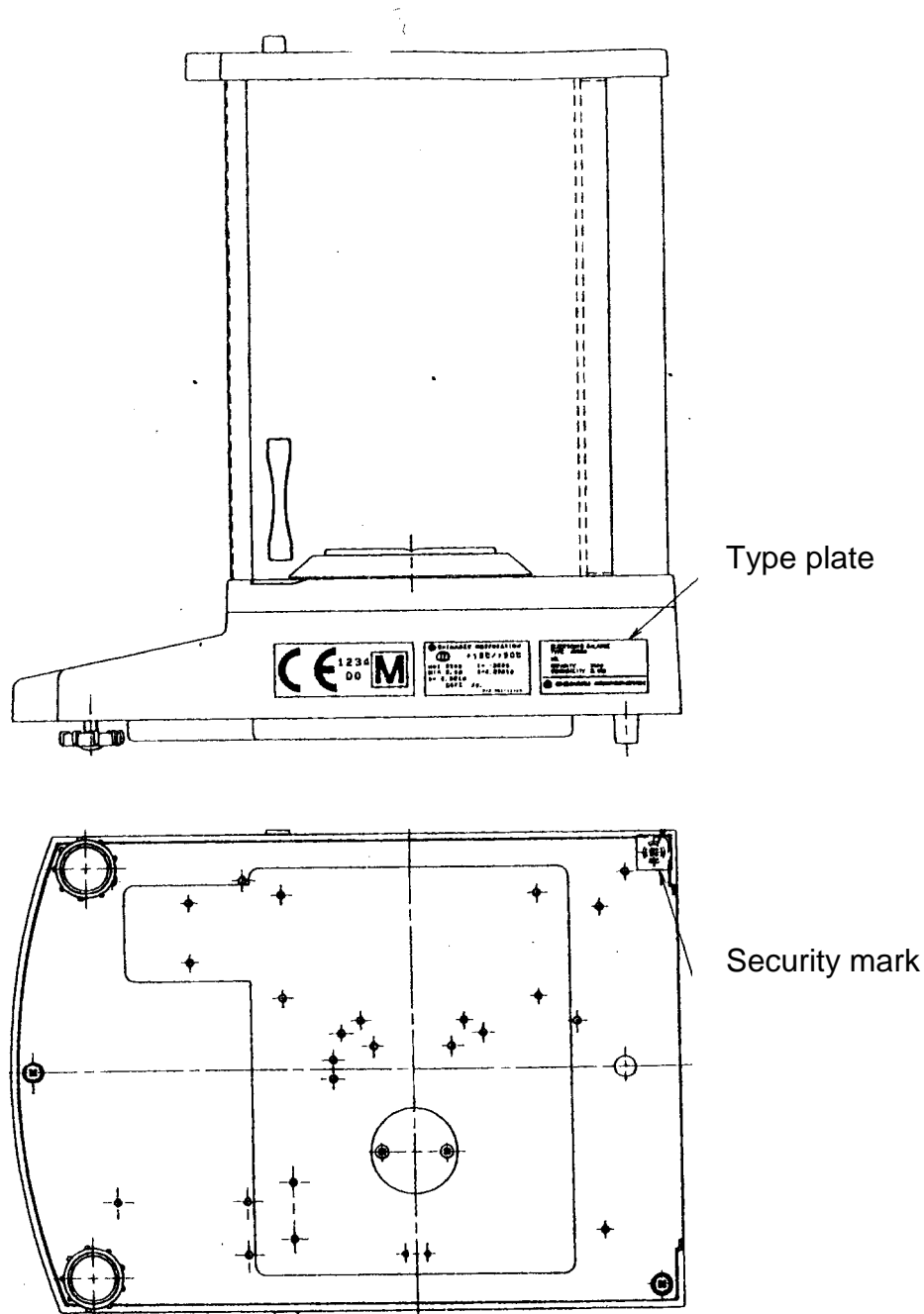

### Important type plate information:

There is a counter on the type plate that counts upwards if the internal adjustment weight is re-adjusted using service mode. This counter is indicated as follows: “**Log. No. A01**”. The display indicates the number A01 after the balance has been connected to the power supply. If the internal adjustment weight has been adjusted using the service mode, this counter would count upwards and A02 would appear after the balance is connected to the power supply. This would invalidate any calibration in calibrated condition.

The counter on the type plate and the number indicated on the display must coincide after the balance is connected to the power supply!

**If these numbers do not coincide, calibration is not valid.**

## 4 Operating menu of the balance

The operating menu of the balance can be used to set up the balance to meet your specific needs. The operating menu is normally set up during manufacture and does not require any modifications. Nevertheless, the balance can be customised for special applications through the operating menu.

### 4.1 Modifying the settings

To change certain settings, select the respective functions.

A function can be modified by the following three steps:

- **Menu call**
- **Function setting**
- **Confirm and store**

To adjust a function, the **ON/OFF/ESC**, **CAL/MENU** and **TARE/↵**-key are equipped with special functions.

### 4.2 Setting modifications

**CAL/MENU** = Menu selection and menu option processing from top down (↓).

**TARE/↵** = Select function.

Once the display function has been selected with the **CAL/MENU** key, perform a call by using the **TARE/↵**-key for the modification.

**CAL/MENU** = Select one of the possible function settings. Processing of menu options from top down.

**TARE/↵** = Confirmation and storage of setting with **TARE/↵**-key of current display.

The → standby indicator will indicate the setting for the current function.

**ON/OFF/ESC** = Exit from function

*Press the **ON/OFF/ESC** key function briefly to return to previous menu.*

*Press the **ON/OFF/ESC** key function for longer to return to weighing mode.*

### 4.3 Menu call

Perform the modification test once. Change the “Auto-Zero“ function to OFF and then to ON.

- Turn the balance on by using the **ON/OFF/ESC** key.
- Press the **CAL/MENU** key until FUnC.SEL appears.
- Press the **TARE/↵** key only once until CAL appears.
- Press the **CAL/MENU** key once until trC :on appears.
- Press the **TARE/↵** key once.  
The “Auto-Zero“ function is selected.  
The → standby indicator indicates the setting of the current display.

- Press the **CAL/MENU** key.

This means:

trC :oF    Auto-Zero is off.

trC :on    Auto-Zero is on

Select trC :oF

- Press the **TARE/↵** key once.  
A colon appears when the change is stored.
- Press the **ON/OFF/ESC** key.  
To exit the menu, press the **ON/OFF/ESC** key at least 2 sec.

**Note:**

If you wish to store several settings simultaneously on the operating menu, you do not need to exit the menu each time. Several settings can be set up before exiting the menu.

## 4.4 Operating menu summary

### 4.4.1 Selection of main menu

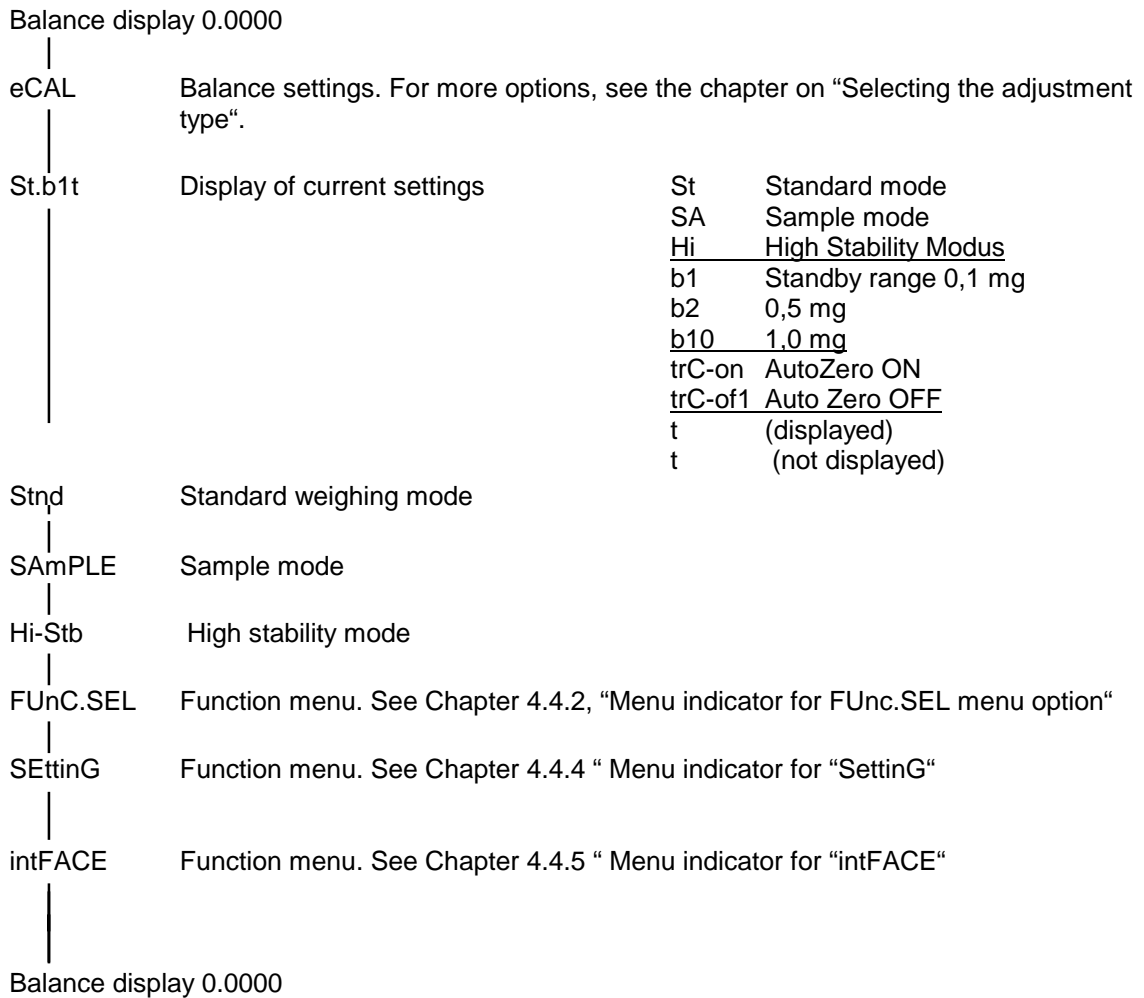

#### 4.4.2 Menu indicator for FUnC.SEL menu option

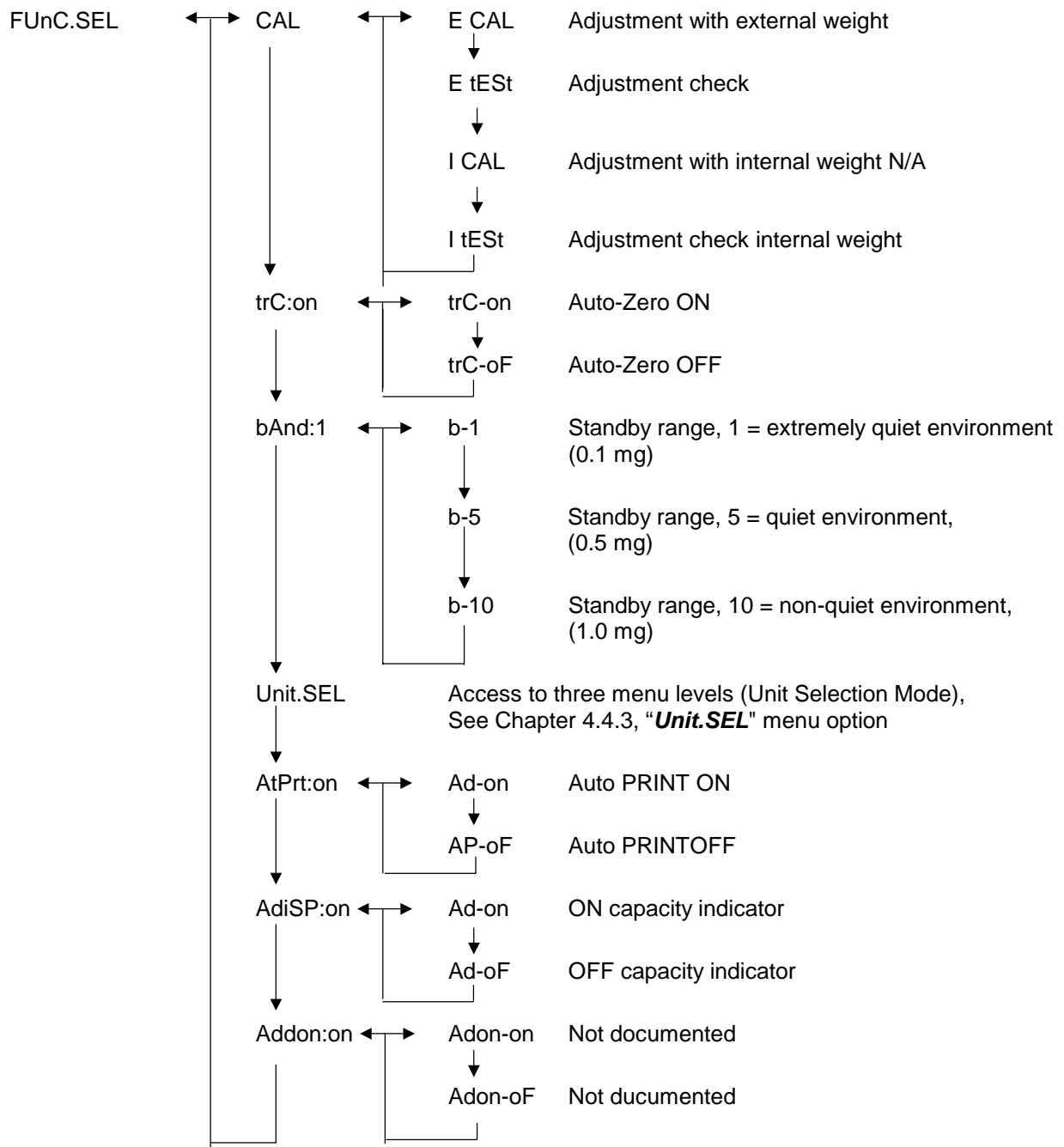

**4.4.3 Menu indicator for Unit.SEL menu option**

Unit.SEL ←	U-	g	grams (0.0001 g)
	↓		
	U-	mg	Milligrams (0.1 mg)
	↓		
	U-	%	Percentage
	↓		
	U-	PCS	Parts
	↓		
	U-	ct	Carats (0.001 ct)
	↓		
	U-	mom	Momme (0.00005 mom)
	↓		
	U-	,d	Not documented
	↓		
	U-	d	Not documented
	↓		
	U-	Lb	Pounds
	↓		
	U-	Oz	Ounce calculation
	↓		
	U-	Ozt	Troy ounce calculation
	↓		
	U-	HK	Hong Kong
	↓		
	U-	SPorE	Singapore
	↓		
	U-	tiwAn	Taiwan
	↓		
	U-	mAL	Malaysia
	↓		
	U-	CHinA	Chinese
	↓		
	U-	dwt	Pennyweight
	↓		
	U-	GN	Grain
	↓		
	U-	m	Mesgal
	↓		
	U-	b	Boats
	↓		
	U-	t	Tare
	↓		
	U-	o	Parts per pounds

Calculation factor 1g:

= 0.001kg  
= 1000mg  
= 5ct  
= 0.266667 mom  
= 0.00220462 Lb  
= 0.0352740 Oz  
= 0.0321507 Ozt  
= 0.0267173 TL-HK  
= 0.0264555 TL-S'pore  
= 0.0266667 TL-Taiwan  
= 0.0264600 TL-Malaysia  
= 0.0266071 TL-China  
= 0.643015 dwt  
= 15.4324 GN  
= 0.216999 m  
= 0.0657895 b  
= 0.0857339 t  
= 1.128766770

#### 4.4.4 Menu indicator for SETTING menu option

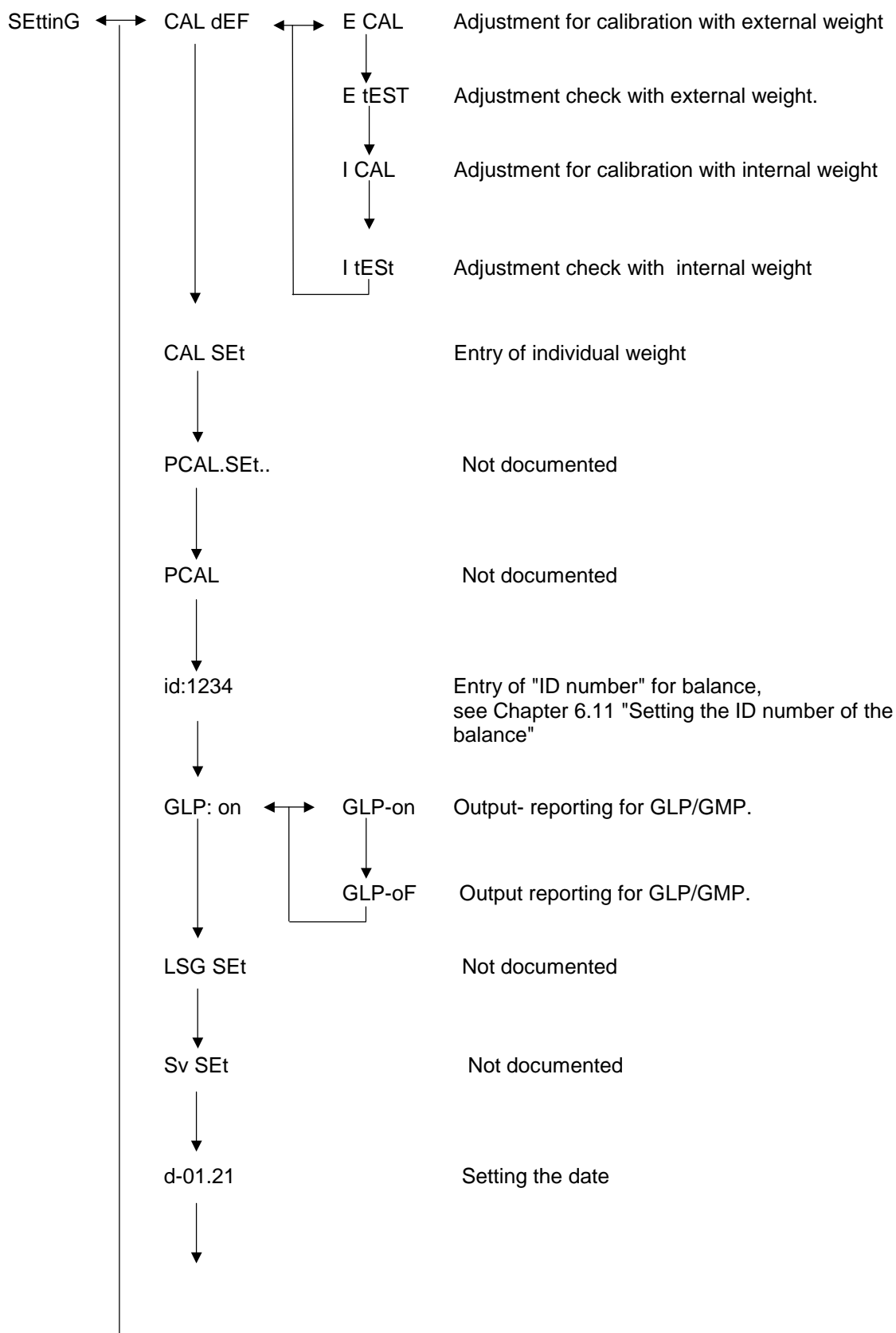



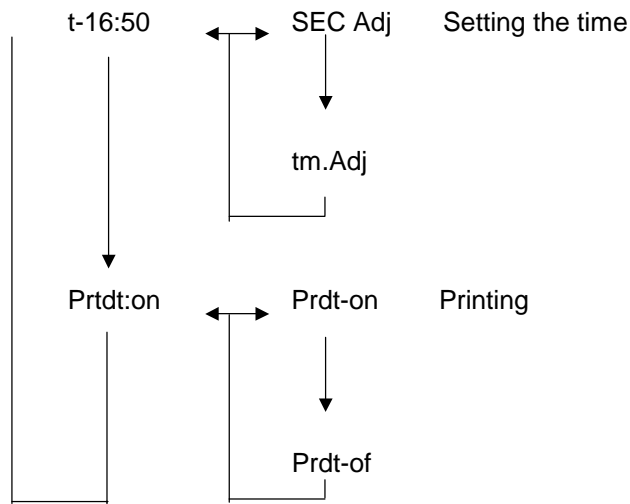

#### 4.4.5 Menu indicator for intFACE menu option

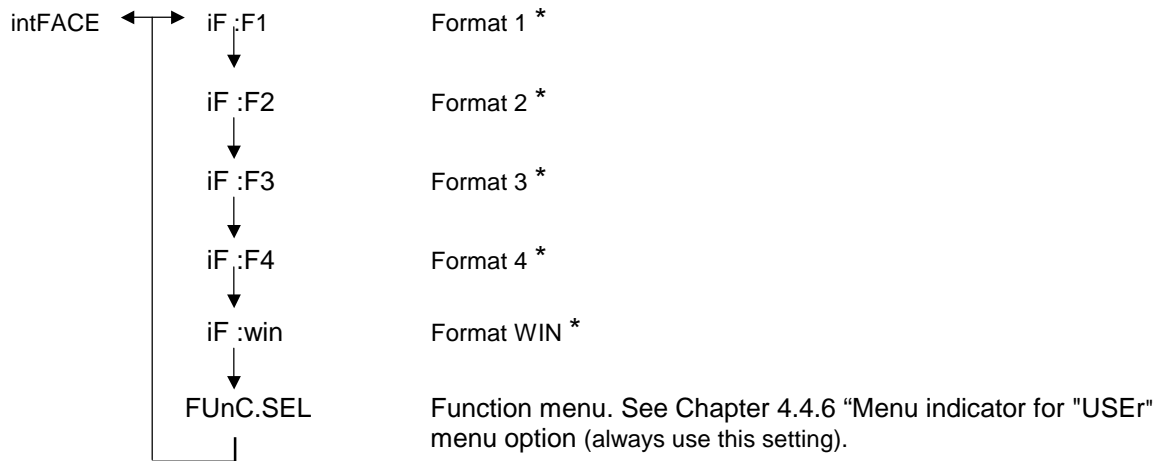

\* Not documented

### 4.4.6 Menu indicator for iF :USER menu option

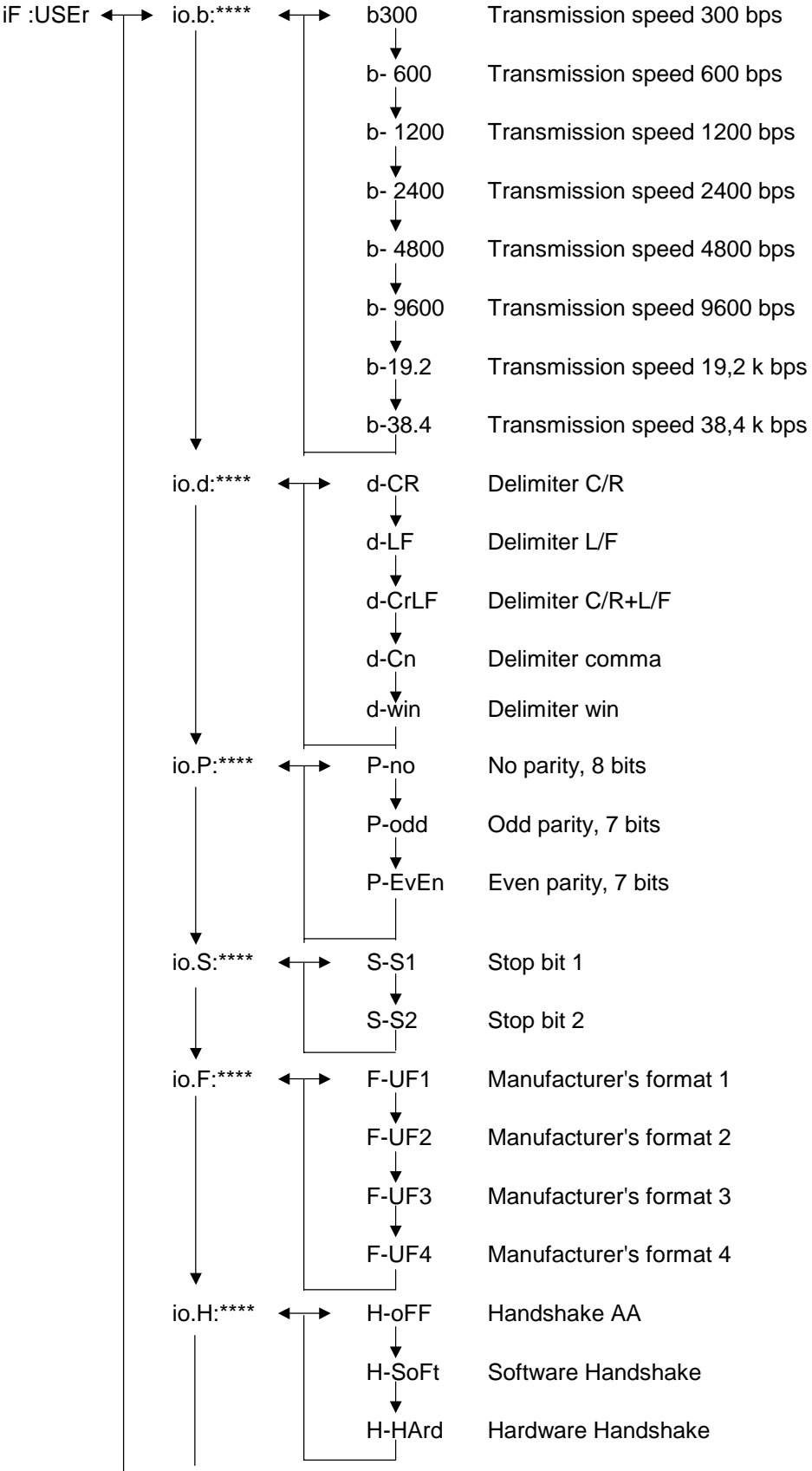

## 5 Adjustment

### 5.1 Adjustment with external weight



Balances without automatic internal calibration are supplied with an external weight. This external weight can be used to check and set balance precision at any time.

During the set-up, balance sensitivity is adapted to the ambient conditions.

Adjust your new balance at the balance location after a warm-up period before initial use. If there is any change in location or ambient conditions (particularly temperature), the balance must be readjusted. This kind of adjustment should be carried out regularly at all costs due to the high accuracy of the items of equipment.



The weight symbol  will appear on the display if adjustment becomes necessary.

#### Sequence:

- (1) Remove the items being weighed from the balance plate and press the **TARE/** -key; the display will indicate zero.
- (2) Press the **CAL/MENU** key until E cal appears.  
Note: Balances without automatic internal adjustment are set at “E cal” as a standard, i.e. set for adjustment using an external weight. This setting can be checked using the “Setting” menu, see chapter 4.4.4, and altered if necessary.
- (3) Then press the **TARE/** -key - The display will indicate 0.0000, along with the weight symbol.
- (4) The zero will be flashing. The weight value required for the setting will start to flash.
- (5) Place the necessary adjustment weight on the balance plate.
- (6) Wait until the display flashes, indicating 0.0000.
- (7) Then remove the weight from the balance plate.
- (8) The display will indicate CAL END for several seconds and then return to normal. The adjustment has been done successfully.





## 5.2 *Checking the balance with the internal weight (BA045 BA058)*

### Sequence:





- (1) Remove the items being weighed from the balance plate and press the **TARE/**  - key ; the display will indicate zero.
- (2) Press the **CAL/MENU** key until I CAL appears.  
Note: Balances with automatic internal adjustment are set at “I cal” as a standard, i.e. set for adjustment using an internal weight. This setting can be checked using the “Setting” menu, see chapter 4.4.4, and altered if necessary.
- (3) Now press the **TARE/** -key. The display will indicate CAL 2.
- (4) The display will subsequently indicate CAL 1 followed by CAL 0.
- (5) The display will indicate CAL END before reverting to weighing mode. Adjustment has been completed successfully.

## 5.3 *Checking the balance with the external weight*

### Sequence:

- (1) Remove the items being weighed from the balance plate and press the **TARE/** -key; the display will indicate zero.
- (2) Press the **CAL/MENU** key until FUnC.SEL appears.
- (3) Then press the **TARE/** -key. The display will indicate CAL, then press **TARE/** -key. again ( E CAL appears ) .
- (4) Press the **CAL/MENU** key until E tEst appears, then press the **TARE/** -key; the check will start.
- (5) The zero will be flashing. Following this the weight value will flash for adjustment.
- (6) Place the necessary adjustment weight on the balance plate.
- (7) The zero weight will now be flashing on the balance.
- (8) Remove the weight from the balance plate.
- (9) If no error message is issued, the balance will display zero again, thereby indicating that the check has been successful.

## 5.4 *Checking the balance with the internal weight (BA045 BA058)*

- (1) Remove the items being weighed from the balance plate and press the **TARE/**  - key; the display will indicate zero.
- (2) Press the **CAL/MENU** key until FUnC.SEL appears. Then press the **TARE/**  key.
- (3) When CAL appears, press the **TARE/** -key.
- (4) Press the **CAL/MENU** key until itESt appears, then press the **TARE/** -key ; the check will start.
- (5) E tESt 2 appears. The zero point is being checked.
- (6) E tESt 1 appears. The internal weight is being checked.
- (7) E tESt 0 appears. The zero point is being checked again.
- (8) The check is finished. The difference to the previous adjustment will be displayed.
- (9) If no error message is issued, the balance displays tEStEND for some seconds and then it will display zero again, thereby indicating that the check has been successful.

## 6 Application Programs

### 6.1 Auto-Zero function

The Auto-Zero function can be used to automatically tare small deviations from a zero display.

Auto-Zero ON                      Deviations from zero are tared automatically.

Auto-Zero OFF                     Deviations from zero are **not** tared automatically.

#### Menu call:

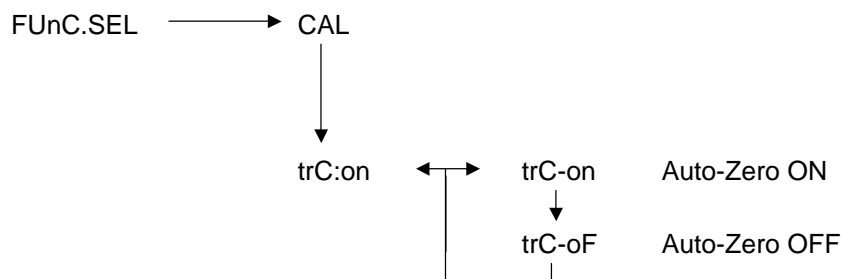

### 6.2 Filter

Filter settings can be used to optimise the weight display for special applications.

#### Menu call:

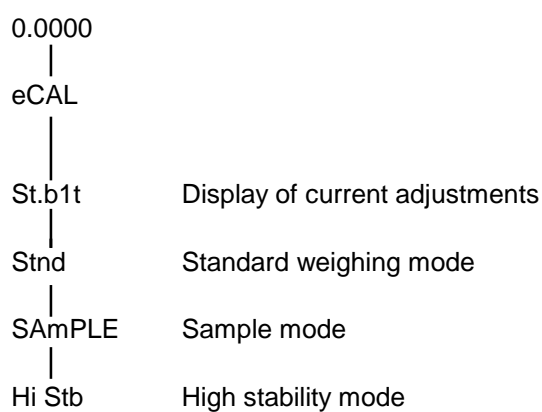

### 6.3 Standby range

The standby signal lights when the weighing result is stable within the indicated standby range.

b = 1                      Extremely quiet environment

b = 5                      Quiet environment

b = 10                     Non-quiet environment

#### Menu call:

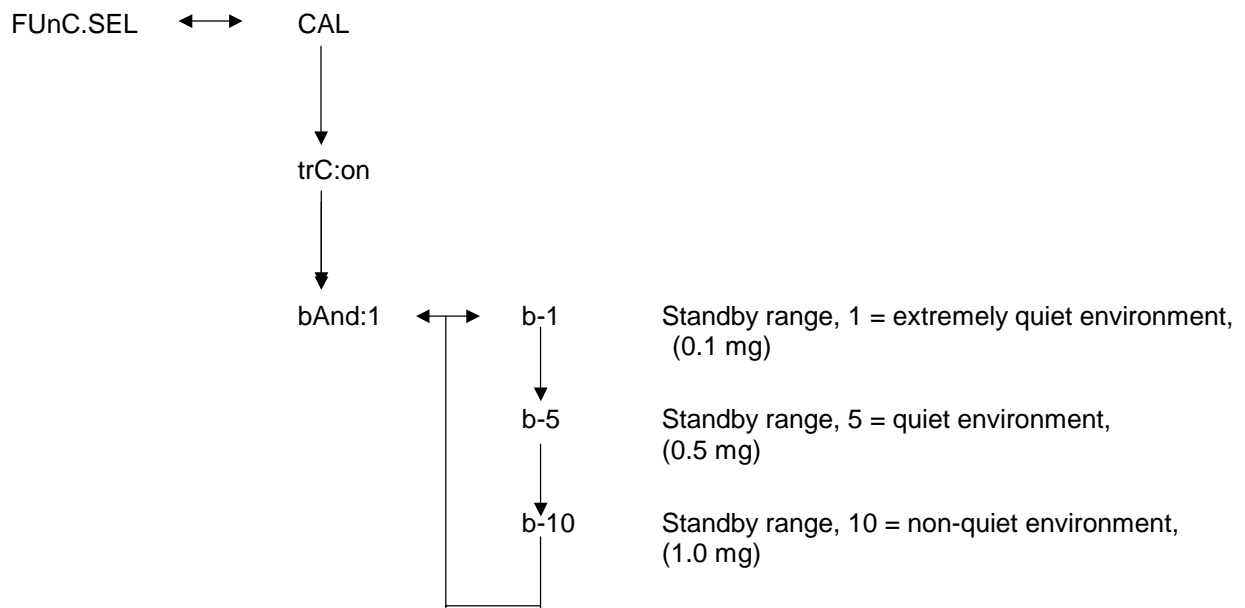

## 6.4 Changing the units

The basic weight unit is the unit used by the balance for weighing after being turned on.

### Menu call

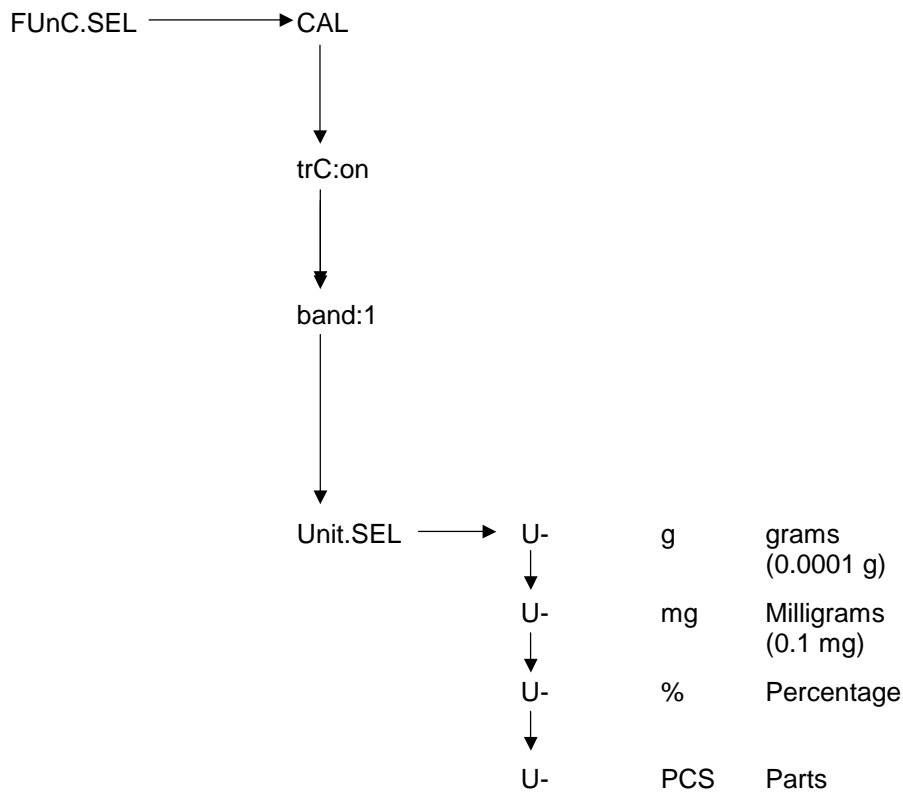

..... for more units, see the menu

Use the **CAL/MENU** key to select the desired weight unit. Press the **TARE/**  **-** key to check the new set-up. The standby indicator will appear.

The standby indicator will appear in the case of all selected units.

The actual change in standby units in the weighing mode occurs when the **UNIT/**  **key** is pressed. The selected units appear here.





## 6.5 Percentage weighing

**Display symbol:** %

Percentage weighing allows the weight to be expressed as a percentage of the reference weight. The indicated weight value is accepted as the preset percentage (standard setting: 100%).

Condition: Perform the change of units in %, see Chapter 6.4 "Changing the units".

### Sequence:

- (1) Remove the items being weighed from the balance plate and press the **TARE/** -key; the display will indicate zero.
- (2) Place the adjustment weight = 100% on the balance plate.
- (3) Use the **UNIT/**  key to select the change of units in %.
- (4) Press and hold the **CAL/MENU** key (2 sec) until SEt 100% appears on the display.
- (5) The display will indicated 100% when the **TARE/** -key is pressed.

## 6.6 Counting



### Display symbol: PCS

The counting program allows the weight calculation to be converted into number of parts with respect to a reference weight. The displayed weight will be taken for a preset number of parts (setting for 10, 20, 50 or 100 parts).

Counting accuracy is higher when there are more parts. The minimum reference weight is 0.01 g.

Condition: Change the units to PCS,  
see Chapter 6.4 "Changing the units"

### Sequence:

- (1) Remove the items being weighed from the balance plate and press the **TARE/**  - key; the display will indicate zero.
- (2) Place the parts to be weighed on the plate
- (3) Use the **UNIT/** key  to select the change of units in PCS
- (4) Press and hold the **CAL/MENU** key (2 sec) until SEt 10 appears on the display.
- (5) Use the **CAL/MENU** key to select the respective number of parts, for the parts located on the balance plate (SEt 10 PCS, SEt 20PCS, SEt 50 PCS, SEt 100 PCS).
- (6) Press the **TARE/**  -key to display the number of parts that has selected. You may now gradually add more parts to the balance plate; the display is expressed in number of parts.

### Note:

If the "Err 20" error message is displayed, the reference weight is too small for the number of parts.

## 6.7 Auto-print display

The Auto Print function sends the value on the display after standby to a DATA I/O and RS232C interface. For subsequent printing, the balance must first be unloaded.

Auto Print ON                      Printing output to interface

Auto Print OFF                    No printing output to interface

### Menu call:

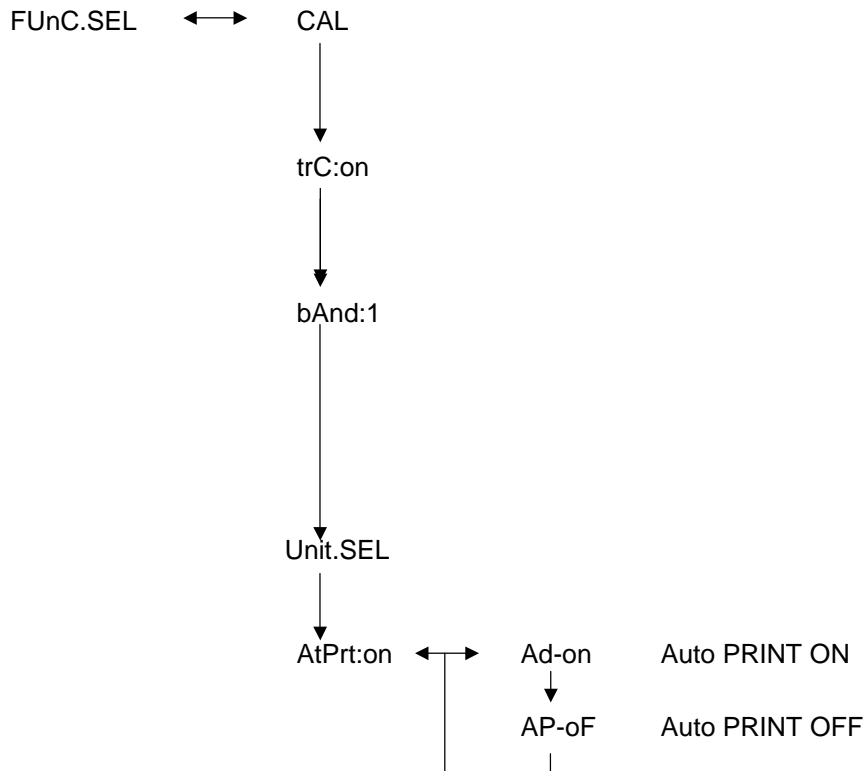

## 6.8 Capacity indicator (analog display)

The capacity is displayed on the left of the display panel. The weight value is displayed in both digital and analog form.

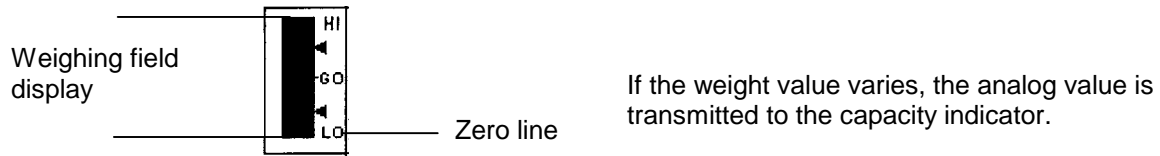

Analog display ON            with additional analog display

Analog display OFF        without analog display

### Menu call:

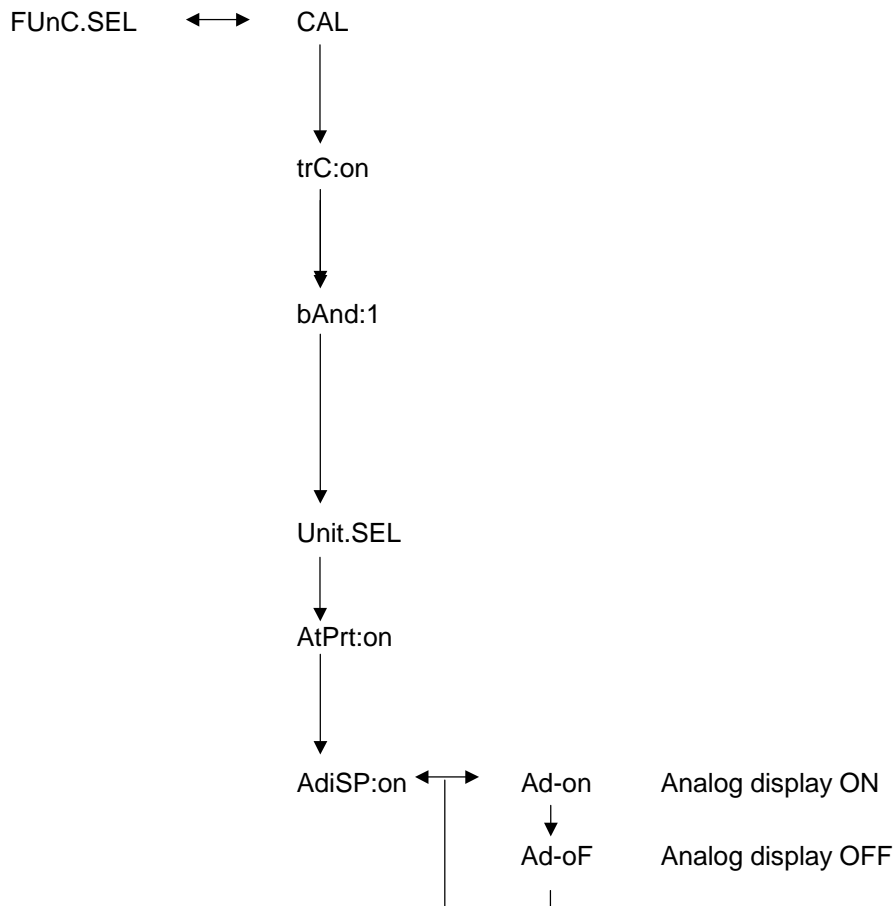

## 6.9 Selecting the adjustment type

The desired adjustment type can be preset .

ECAL	Adjustment with external weight
E tEst	Adjustment check
I CAL	Adjustment with internal weight
ItEst	Adjustment check with internal weight

### Menu call:

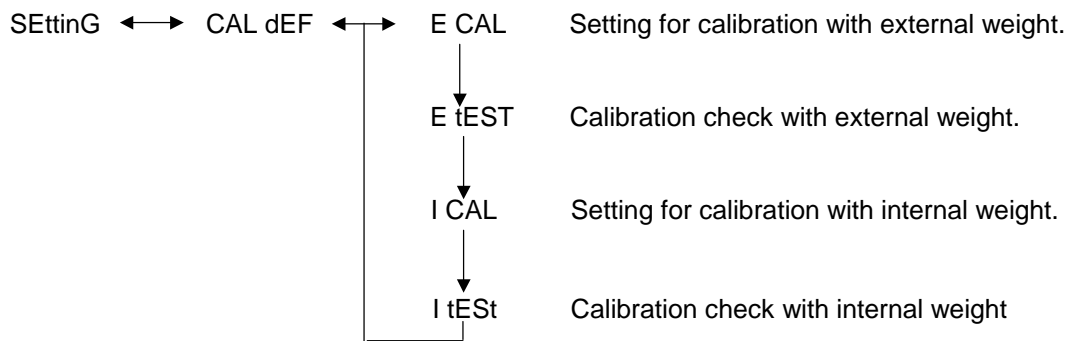

### Sequence:

- (1) Press and hold the **CAL/MENU** key until the Function Setting appears on the display. Press the **TARE/↵**- key
- (2) Appears **CALdEF**, press **TARE/↵**- key
- (3) ECAL,EtEst, I CAL or ItEst can be selected.
- (4) Use the **CAL/MENU** key to select the adjustment type. Press the **TARE/↵**- key.
- (5) Use the **ON/OFF/ESC** key to return to weighing mode.



## 6.10 Adjusting the adjustment weight

The external adjustment weight can be displayed variably. Capture the value of the adjustment weight here. The selected adjustment weight must be used during the adjustment.

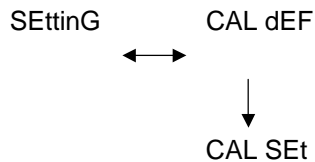
### Menu call:



### Sequence:

- (1) Press and hold the **CAL/MENU** key until the function **SEttinG** appears on the display. Press the **TARE/↵**- key
- (2) Press and hold the **CAL/MENU** key until **CAL SEt** appears on the display. Press the **TARE/↵**- key
- (3) Use the **PRINT/** key  to select the figure you wish to change (from left to right).
- (4) Use the **UNIT/** key  to increase the numeric value of the selected figure
- (5) If the weight has changed, press the **TARE/↵**- key to check the value weight. Use the **ON/OFF/ESC** key to return to weighing mode.



## 6.11 Setting the ID number

Remarks: The balance ID number will be printed on the printout.

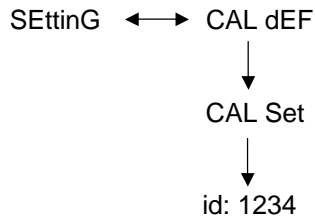
### Menüaufruf:



### Sequence:



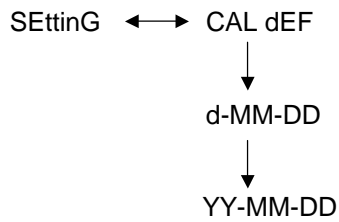

- (1) Press and hold the **CAL/MENU** key until the function **SettinG** appears on the display. Press the **TARE/↵**- key
- (2) Press and hold the **CAL/MENU** key until ID e. g. **id:1234** appears on the display. Press the **TARE/↵**- key
- (3) Use the **PRINT/ key**  to select the figure you wish to change (from left to right).
- (4) Use the **UNIT/ key**  to increase the numeric value of the selected figure
- (5) If the weight has changed, press the **TARE/↵**- key to check the value weight. Use the **ON/OFF/ESC** key to return to weighing mode.

## 6.12 Setting the date

Menu call:



Sequence:

- (1) Press and hold the **CAL/MENU** key until the function setting appears. Press the **TARE/**  - key
- (2) Press and hold the **CAL/MENU** key until d-MM-DD appears (MM:month, DD:day)
- (3) Press the **TARE/**  - key in order to set the current date /YY: year, MM: month, DD: day).
- (4) Use the **PRINT/**  key to select the figure you wish to change (from left to right).
- (5) Use the **UNIT/**  key to increase the numeric value of the selected figure.
- (6) Use the **ON/OFF/ESC** key to return to weighing mode. The setting is stored.



## 6.13 Setting the time

### 6.13.1 Entering seconds

#### Menu call:

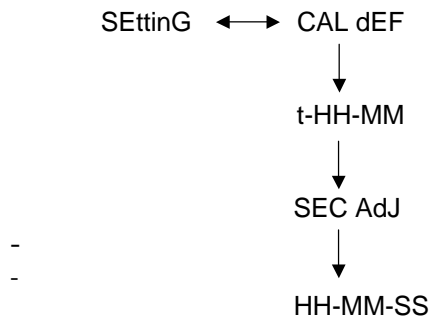

#### Sequence:



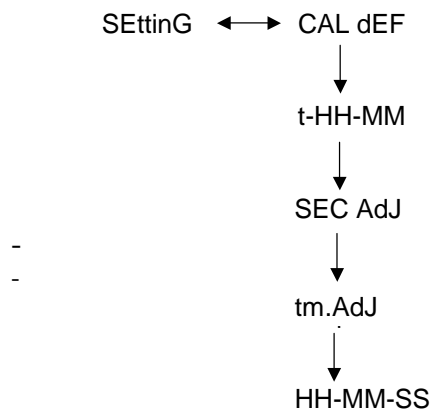

- (1) Press and hold the **CAL/MENU** key until the function setting appears. Press the **TARE/↵** key.
- (2) Press and hold the **CAL/MENU** key until t-HH-MM appears (HH:hour, MM:min.)
- (3) Press the **TARE/↵** key, SEC AdJ will appear.
- (4) Press the **TARE/↵** key to set the desired time. If the **TARE/↵** key is pressed between 00 and 29 this will be rounded down to zero sec; if pressed between 30 and 59 this will be rounded up to the next full minute.
- (5) Use the **ON/OFF/ESC** key to return to weighing mode. The setting is stored.

## 6.13.2 Setting hours and minutes

### Menu call:



### Sequence:

- (1) Press and hold the **CAL/MENU** key until the function setting appears. Press the **TARE/**  key.
- (2) Press and hold the **CAL/MENU** key until t-HH-MM appears (HH:hour, MM:min.)
- (3) Press the **TARE/**  key, SEC AdJ will appear.
- (4) Press the **CAL/MENU** key, tm.AdJ will appear.
- (5) Press the **TARE/**  key to set the current time (HH: hour, MM: min., SS: sec.).
- (6) Use the **PRINT/**  key to select the figure you wish to change (from left to right). The figure to be changed will flash.
- (7) Use the **UNIT/**  key to increase the numeric value of the selected figure.
- (8) Use the **ON/OFF/ESC** key to return to weighing mode. The setting is stored.

## 6.14 Printing off date and time

Print off is only carried out when adjusting.

### Menu call:

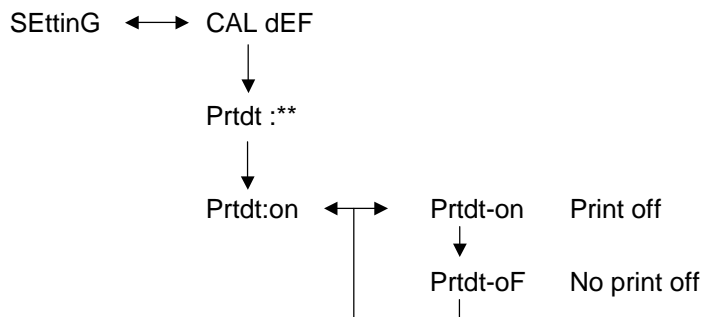

### Sequence:

- (1) Press and hold the **CAL/MENU** key until the function setting appears. Press the **TARE/↵**- key .
- (2) Press and hold the **CAL/MENU** key until “Prtdt:\*\*” appears (**on**:print off, **oF**: no print off).
- (3) Press the **TARE/↵**- key “Prtdt-on” will appear.
- (4) Press the **CAL/MENU** key to select the desired setting (**-on** or **-oF**). The standstill indicator **➔** indicates which setting is currently in function.
- (5) Press the **TARE/↵**- key to save the setting that is currently being displayed.
- (6) Use the **ON/OFF/ESC** key to return to weighing mode. The setting is stored.

## 7 Description of interfaces

### 7.1 General instructions

This description is addressed to users who wish to connect the balance unit to a computer or any another peripheral through the RS232 C interface which is included in the balance.

The computer can be used to change, start and monitor the weighing functions.

### 7.2 General data

Type of interface	Serial
Interface operation	Full-duplex asynchronous
Level	RS 232 C specification
Transmission speed	300, 600, 1200, 2400, 4800, 9600, 19200, 38400 Baud
Character coding	ASCII (7-bit or 8-bit)
Character format	Start bit 1

### 7.3 Example for cable wiring:

25-pin balance		9-pin PC
Pin 2	—————	Pin 2
Pin 3	—————	Pin 3
Pin 6	—————	Pin 4
Pin 7	—————	Pin 5
Pin 20	—————	Pin 6
Pin 5	—————	Pin 7
Pin 4	—————	Pin 8
Pin 22	—————	Pin 9

## 7.4 Formatting input and output data

In the following description, [u] means a blank character and [DL] the end of the command.

### Input data

[COMMAND CODE] + [DL]  
See Chapter 7.5, "Entering commands"

### Output data

- With measurement display:  
S-200.0000 g u [DL]

Polarity      positive..... Blank character ( u )  
                  negative..... Menus ( - )

Stability information  
Available with stability display and information  
stable ..... S  
unstable ..... U

- The display will indicate oL or -oL,  
U- uuu oL uuu [DL]

Polarity      positive..... Blank character ( u )  
                  negative..... Menus ( - )

Stability information  
Available with stability display and information  
stable ..... S  
unstable ..... U

## 7.5 Entering commands

If the balance is connected to a personal computer or printer, the following commands are available.

See Chapter 7.4, "Formatting input and output data"

If errors not appearing here are transmitted to the balance, proper balance operation is not guaranteed. In this case, unplug the balance from the power outlet for 10 seconds.

Command code	Function	Content
D01	Continuous printing	Weighing data are issued continuously (every 230 ms).
D05	Single transmission of data	Identical to PRINT key
D06	Automatic output at printer	See the respective settings in AUTO PRINT.
D07	Single output of data with stability information	The data are issued with S: If stability indicator is displayed U: If adjusted without stability
D08	Single output of data with stability status	Data output after transmission of command
D09	Output stop	AUTO PRINT finishes and the output
Q	ON/OFF	Standby and weighing status
T	Tare	See the respective settings in TARE key.
TS	Wait for stable tare	Tare is performed after standby.
CAL	Setting	
R	Restart	Reset

## 8 Troubleshooting

If the cause is marked with an [S], contact Impact Test Equipment [www.impact-test.co.uk](http://www.impact-test.co.uk)

when	Breakdown	Possible causes
before weighing	<p>No values appear on the display.</p> <ul style="list-style-type: none"> <li>• The weight display changes constantly.</li> <li>• The standby indicator is not lighted.</li> <li>• The measurement value varies considerably.</li> <li>• The weight result is obviously wrong.</li> <li>• The weight display indicates CAL d.</li> </ul>	<ul style="list-style-type: none"> <li>• The AC power supply is not connected.</li> <li>• The balance is not plugged in.</li> <li>• There is excessive vibration or air current. <ul style="list-style-type: none"> <li>-&gt; Change the location.</li> <li>-&gt; Change the standby indicator.</li> </ul> </li> <li>• The product being weighed vaporises. <ul style="list-style-type: none"> <li>-&gt; Cover the item being weighed.</li> </ul> </li> <li>• The weighing product is loaded. <ul style="list-style-type: none"> <li>-&gt; Place a sample in a metal container and weigh it.</li> <li>-&gt; If you must weigh, for example, a plastic disc or similar item, the plate you are using is larger than the weighing plate.</li> </ul> </li> <li>• The temperature of the product being weighed is higher or lower than the one in the weighing chamber. <ul style="list-style-type: none"> <li>-&gt; Bring both to the same temperature.</li> <li>-&gt; Increase the standby of the balance.</li> </ul> </li> </ul>
during weighing	<ul style="list-style-type: none"> <li>• The balance varies the automatic setting.</li> <li>• ERROx error is displayed.</li> <li>• Err20 is displayed.</li> <li>• Err24 is displayed.</li> </ul>	<ul style="list-style-type: none"> <li>• Influence of electrical noise (mains voltage) or strong electromagnetic radiation. <ul style="list-style-type: none"> <li>-&gt; Remove the balance from the noise source.</li> </ul> </li> <li>• Air current inside and outside the weighing chamber. <ul style="list-style-type: none"> <li>-&gt; If the balance is not being used, open the door of the weighing chamber about 1-2 mm.</li> </ul> </li> <li>• Mechanical interference <ul style="list-style-type: none"> <li>-&gt; [S]</li> </ul> </li> <li>• Extreme variations in temperature inside the room <ul style="list-style-type: none"> <li>-&gt; Change the location</li> </ul> </li> <li>• Hardware is missing. <ul style="list-style-type: none"> <li>-&gt; [S]</li> </ul> </li> <li>• The numeric value entered is wrong.</li> <li>• An attempt was made to delete a registered unit. This is not allowed. <ul style="list-style-type: none"> <li>-&gt; Shown if only one unit or one inverted weighing unit is registered.</li> </ul> </li> <li>• Batteries too weak. <ul style="list-style-type: none"> <li>-&gt; Replace the batteries.</li> </ul> </li> </ul>

when	Breakdown	Possible causes
During weighing	<ul style="list-style-type: none"> <li>• UtoU10 appears on the display.</li> </ul>	<ul style="list-style-type: none"> <li>• Command code allowed for modification</li> <li>-&gt; <u>Unplug the power cord, then plug it back in after 10 sec. If the balance displays this for more than 24 hours, accurate measurement will not be possible.</u></li> </ul>
	<ul style="list-style-type: none"> <li>• Constant soft noise.</li> </ul>	<ul style="list-style-type: none"> <li>• Such noise is normally caused by blows when loading the balance. This noise is completely normal.</li> </ul>
During adjustment	<ul style="list-style-type: none"> <li>• No data can be sent or received.</li> </ul>	<ul style="list-style-type: none"> <li>• Erroneous report parameter</li> </ul>
	<ul style="list-style-type: none"> <li>• CAL E2 is displayed.</li> </ul>	<ul style="list-style-type: none"> <li>• There was a weight on the balance plate during adjustment.</li> <li>-&gt; Unload the balance and readjust.</li> </ul>
During adjustment	<ul style="list-style-type: none"> <li>• CAL E3 is displayed</li> </ul>	<ul style="list-style-type: none"> <li>• The reference weight used during adjustment is wrong.</li> </ul>
	<ul style="list-style-type: none"> <li>• CAL E4 is displayed</li> </ul>	<ul style="list-style-type: none"> <li>• The balance is defective.</li> <li>-&gt; [S]</li> </ul>

## 8.1 Error display

If the cause is marked with an [S], contact Impact Test Equipment [www.impact-test.co.uk](http://www.impact-test.co.uk).

Error message	Possible causes	Solution
CAL E2	The zero points deviates too much from the adjustment.	Empty the balance plate.
CAL E3	Large deviation with respect to PCAL.	Use a proper weight.
CAL E4	The sensitivity deviates too much from the adjustment.	Use a proper weight.
CHE x	The balance stops on this display.	->[S]
Err 0x	Abnormal internal balance chamber.	-> [S]
Err 20	A wrong value has been entered.	Repetition of numeric value.
Err21	The necessary conditions and numeric value have not been met.	Check the analog mode g.
Err24	The balance does not store the settings properly, voltage fluctuations.	Check the power supply.



## 9 Important information

These electronic scales are a precision instrument. Electromagnetic fields can cause major display discrepancies. The scales must then be repositioned away from electromagnetic fields. All sources of environmental interference, such as drafts and vibrations, should be avoided. Sudden changes of temperature should be avoided. The scales must be reset to match changes in temperature.

The scales are not hermetically sealed, therefore avoid high humidity, steam and dust. Do not bring liquids into direct contact with the scales, as these can penetrate into the measuring mechanism. Cleaning material should only be dry or barely damp. Do not use solvents as these can damage paintwork or other plastic parts. Remove damaged items immediately from the scales.

The measuring mechanism will be stabilised by allowing the scales to warm up for a few minutes after switching them on. Place items to be weighed carefully on the scales. Do not place objects on the weighing platform for any period of time, apart from normal use. Sudden shocks or overloading the scales beyond the maximum permitted weight should absolutely be avoided, balance could be damaged.

In case of problems operating the weighing program, switch the scales briefly off and on. The weighing set-up must then be restarted right from the beginning.

Never operate the scales in areas where there is a danger of explosion, the models in this series are not protected against explosion.

Check the scales regularly against, known, external test weights.

**Opening the scales or failing to use them in accordance with the written instructions will invalidate the warranty.**

Please keep all packaging material for possible return of the scales. Scales must only be returned in their original packaging.