

IMPACT
IMPACT
IMPACT

**Sand Equivalent Shaker
AG092**

Impact Test Equipment Ltd
www.impact-test.co.uk - www.impact-test.com
www.impact-testsets.co.uk

www.impact-test.com
www.impact-test.co.uk
www.impact-testsets.co.uk

User Guide
User Guide
User Guide



**Impact Test Equipment Ltd.
Building 21 Stevenston Ind. Est.
Stevenston
Ayrshire
KA20 3LR**

T: 01294 602626

F: 01294 461168

E: sales@impact-test.co.uk

**Test Equipment
www.impact-test.co.uk**

**Test Sieves & Accessories
www.impact-test.com**

**Test Sets to International Standards
www.impact-testsets.co.uk**



Contents

Chapter 1	GENERAL INFORMATION
1.1	GENERALITIES
1.2	IDENTIFICATION
1.3	APPLICATIONS
1.4	STRUCTURE AND OPERATING OF THE MACHINE
Chapter 2	SAFETY INFORMATION
2.1	GENERAL SAFETY STANDARDS
2.2	SAFETY GUARDS
2.3	DANGEROUS PARTS AND RESIDUAL RISKS
2.4	NOISE
Chapter 3	INSTALLATION
3.1	LIFTING
3.2	UNPACKING
3.3	INSTALLATION
3.4	ELECTRIC CONNECTIONS
Chapter 4	FEATURES OF THE APPLIANCE
4.1	DIMENSIONS AND MASS
Chapter 5	OPERATOR'S INTERFACE
5.1	CONTROLS AND SIGNALES
Chapter 6	USE
6.1	SUGGESTIONS
6.2	WORK PLACE
6.3	SAMPLE POSITIONING
6.4	SWITCHING ON THE APPLIANCE
6.5	REGULATION OF STIRRING TIME
6.6	REGULATION OF STIRRING FREQUENCY
6.7	SWITCHING THE APPLIANCE ON
6.8	NORMAL STOP
6.9	EMERGENCY STOP
6.10	STARTING AFTER AN EMERGENCY STOP
6.11	STOP CONTROLLED BY SAFETY CIRCUIT.
6.12	SWITCHING OFF
6.13	TEST START UP
Chapter 7	MANTEINANCE
7.1	STANDARD MAINTENANCE
7.2	PERIODICAL INSPECTION
7.3	PERIODICAL CARES
7.4	SPECIAL MAINTENANCE
Chapter 8	DIAGNOSIS
8.1	DIAGNOSIS
Chapter 9	INACTIVITY
Chapter 10	DECOMMISSIONING THE MACHINE

Chapter 1 GENERAL INFORMATION

1.1 GENERAL FEATURES

- This manual is addressed to the carrier, the installer, the user, the maintenance operator, the scrapping operator.
- Please read it carefully because it informs you about the operating of the machine in safety conditions.
- This manual has to be considered a part of the product and concerns only the machine it is delivered with.
- Keep the manual in order during the whole life of the appliance to consult it for any needs.
- In case of sale, the manual and its enclosures should be given together with the machine.
- The manufacturer assumes no liability for any damages caused by a misuse of the machine.
- The manufacturer has the right to modify this technical literature as well as the machines this refers to without any previous notice.
- Messages meaning:

	WARNING	It shows the procedures that can damage seriously the machine if they are not followed carefully
	DANGER	It shows the procedures that can be dangerous to the operator if they are not followed carefully

1.2 IDENTIFICATION

MANUFACTURER IDENTIFICATION : See the cover page
MACHINE IDENTIFICATION : See the plate on the machine where you can find complete identification data as well as electrical features.

1.3 APPLICATIONS

The motorized sand equivalent shaker has been projected to determine the relevant proportions of clay-like or plastic fines and dust in granular soils and fine aggregates. The test is carried out by means of measuring cylinders containing the samples to be determined. It is recommended to use only cylinders specially manufactured to meet the standards referred to this kind of tests.

The equipment is made for the aim, which it has been conceived for. Any other uses are not allowed.

	WARNING	The instructions given in this operating manual are only made for the right use of the appliance. To carry out the test in the right way, the user must refer to the specific standards in force for the test itself.
---	----------------	---

1.4 STRUCTURE AND OPERATING OF THE MACHINE

The appliance is mainly formed by a device to hold the cylinders (A3). This is equipped with 4 fixing rods and rubber stoppers allowing securing the cylinders containing the solution to be determined.

Inside the frame a cinematic system operated by a motor allows to shake the device and the cylinder (A4) with a constant oscillation.

The frame also contains an electric circuit with a timer that automatically stops the appliance at the end of the test (test time is fixed by the standards in force).

The appliance can be supplied with safety cover, which prevents the operator from touching any of the appliance moving parts. (In accordance with the safety measures foreseen for the EEC countries).

SHAKER WITHOUT SECURITY CABINET AG092



SHAKER WITH SECURITY CABINET AG092/1



Do not hesitate to get in touch with the manufacturer or with the dealer for any further information.

Chapter 2 SAFETY INFORMATION

2.1 GENERAL SAFETY STANDARDS

- **The use, lifting, installation, maintenance and scrapping of the machine are allowed only to qualified staff.** Qualified staffs are composed by people who are authorised by the safety responsible to do any activities due to their experience and acknowledgement of the operating of the machine and of the standards, rules and actions.
The user must be carefully taught about the operating of the machine to avoid any misuse of it and about the safety devices, which the machine could be eventually equipped with. The safety devices will have to be kept always assembled and to be daily checked.
The manufacturers offers training and assumes no liability for any damages due to a misuse of the machine by an unskilled staff.
- The manufacturer recommends following carefully the instructions and procedures of the operating manual and the safety standards concerning the safety devices and the general rules of the work environment.
- Verify the accordance of the machine to the standards in force in the State where the machine has to be installed.
- The operating manual must be carefully read by the safety responsible, by the operators and maintenance engineers. It must always be kept near the machine in order to be able to read it any times it will be necessary.
- Any tampering or modifications of the machine (electric, mechanical etc.) that are not allowed by a written agreement of the manufacturer must be considered as not permitted and the manufacturer will not accept to be charged for any damages.
- The removal or the tampering of the safety devices will be an infringement to the EEC Safety Standards. The manufacturer assumes no liability for any damages.
- The machine has to be installed in places safe from fire and explosions.
- We do recommend using only original spare parts and accessories; on the contrary the manufacturer assumes no liability.
- Be careful that any dangerous situations won't happen during the working; stop immediately the machine in the event that it will not work properly and ask the manufacturer or the Authorised Service Staff of the dealer at once.

The manufacturer assumes no liability for any damages to people, things and animals caused by the non-compliance of the above instructions.

2.2 SAFETY GUARDS

MEANING: Safety devices are all the safety measures which consist of the use of specific technical equipment (guards, cages etc.) to protect the operator from any danger that couldn't be avoided when the appliance is planned.



DANGER

The removal of the safety devices or any tampering of the machine could cause risks to the operator or to any other people.
The manufacturer assumes no liability for any damages to people, things or animals due to the tampering of the safety devices.

FIX AND MOVABLE SAFETY DEVICES

The testing machine is supplied in two versions:

- The STANDARD version (S160N) where no safety devices are foreseen.
- The EUROPEAN CE version (S160-01N) where a safety guard with a safety micro-switch is foreseen. This prevents any access to the moving parts during the test execution.

PASSIVE SAFETY DEVICES

For passive safety devices are meant all those devices avoiding or reducing the risks for the operators. These devices don't require any intervention to be operated.

On the Motorized Shaker, supplied with safety guards, you can find a protection micro switch that stops the machine functioning whenever the carter is not closed correctly or if it is opened during the test running.

ACTIVE SAFETY DEVICE

For active safety devices are meant all those devices avoiding or reducing the risks for the operators. These devices require an active and aware intervention to be operated.

The appliance is equipped with a Main Switch (A1) also acting as safety switch.

By activating it the power supply to the shaker is interrupted and therefore the appliance stops.

2.3 DANGEROUS PARTS AND RESIDUAL RISK

The dangerous place is the space inside and around the machine where the operator could be wounded or damaged.

During some procedures the operator could face some risks of danger.

The risks can be eliminated following carefully the procedures written in this manual and using suitable safety devices.



WARNING

In case the machine installation is not done by the Manufacturer, employ only skilled operators particularly trained for the lifting of heavy machinery.

GENERAL INFO

- **Before starting the standard use of the equipment, ensure that all the components are in good working conditions, check there are no defective or damaged parts. If necessary repair or replace any damaged part.**
- Pay attention to the risk for electric shocks either direct or indirect, due to a failure to the electric system.
- Do not subject the appliance to impacts or shocks.
- Do not expose the appliance to fire, extreme temperatures or weld splatter.
- Avoid corrosive substances to come in touch with the appliance.
- Do not wash the machine using water spray.

DURING THE USE

- **In order to grant the maximum security level for the operator, do not touch any moving part of the appliance during the test execution and wear the convenient protection devices.**
- Do not wear large clothes, ties, watches, or anything else, which could entangle in the machine moving parts.
- If the appliance is not equipped with safety guards, do not stand nearby during the test execution. This will avoid any incidental contact with the cylinder.
- If the appliance is provided with safety guards, pay attention to the risk of finger squeeze when closing the same.

DURING THE LIFTING

- During the lifting take care that the machine is conveniently held and secured and that it cannot slide.
- Do not stand in a direct line with the application of force. Do not allow people entrance under loads that are not conveniently supported by mechanical means.

RISK OR DANGER	PROTECTION DEVICE
FINGER OR ARM SQUEEZE ABRASIONS OR CUTS	REINFORCED GLOVES REINFORCED GLOVES

The manufacturer assumes no liability for any damages to people and things due to a lack of observance of the instructions and the use of the safety devices.

2.4 NOISE

The indicated levels of noise are not necessarily safety levels for the operator.

The exposure levels of the operator are obviously related to the emission levels of the appliance, but other factors influence the exposure levels as the time of exposure, the environment, other appliances installed near to the appliance etc.

The exposure levels permit to value the damages that could be caused by the noise.

Acoustical pressure level equivalent L_{aeq} , in the working place	83 dB(A)
Acoustical power emitted by the appliance L_{WA}	98 dB(A)
Standard above data are referred	EN ISO 3746

	DANGER	<p>The continuous use of the machine together with other noisy appliances could cause a high level of exposure to the noise. If the daily exposure of the operator is equal or higher than 85 dB(A), Safety Devices as headphone are suggested to be worn.</p> <p>If the daily exposure is equal or higher than 90 dB(A), the use of the Safety Device is compulsory.</p> <p>For further information consult the standards of the country where the machine has been installed.</p>
---	---------------	--

Chapter 3 | INSTALLATION

	DANGER	Consult DANGEROUS PARTS AND RESIDUAL RISKS before proceeding
---	---------------	---

3.1 | TRASPORTO

3.1 | LIFTING

The operating instructions must be respected during:

- The lifting and the storing
- The first installation
- The further installations

The machine is usually packed in a wooden case to be moved by a forklift.

During the lifting of the case, it is recommended to take the utmost care and to follow the lifting directions labelled on the case. If possible, use forklift or crane and fasten the case with belts and ropes, avoid the use of chains.

	DANGER	Pay attention to avoid impacts and turnovers.
---	---------------	---

	DANGER	Protect the machine from the atmospheric agents. Water and humidity could oxidise it, damaging it seriously.
---	---------------	--

3.2 | UNPACKING

After removing the package, check that any parts of the machine are not damaged. In case of doubt, **DO NOT USE THE MACHINE** and ask the manufacturer.

	DANGER	The materials used for the package (plastic, polystyrene, screws, nails, wood etc.) have to be kept far from children. They must be thrown away in a proper collection centre.
---	---------------	--

	WARNING	Pay attention to avoid impacts and turnovers.
---	----------------	---

**WARNING**

Before throwing away the package, pay attention that any accessories, manuals, documents, spare parts are not inside.

3.3 INSTALLATION

The machine has to be placed in an environment suitable for the aim it has been conceived for (laboratory use). Skilled operator must do the installation.

ALLOWED TEMPERATURE	from + 5°C to + 40°C
ALLOWED HUMIDITY	from 30% to 95%
O.S.L. MAX. HEIGHT	1000 m

GENERAL WARNINGS

- The machine must be installed so that it is free from each side. This will grant its easy maintenance.
- No unauthorized people or dangerous objects must be allowed to get in the area near the appliance.

3.4 ELECTRIC CONNECTIONS**DANGER**

Skilled operators must arrange the electric connections.
 Before connecting, see the attached electric diagram and the plate on the machine for the information about the voltage, the frequency, etc.
 Connect the ground by the terminal PE (yellow-green) before making any other connections.
 Apply a knife switch at the top of the connecting cable of the machine to the power system.
 The knife switch must be combined with a safety device against the overload with a differential switch (safety switch).
 The technical features of the safety device must be in accordance with the standards in force in the country where the machine has been installed.

ELECTRIC TOLERANCES:

- Real voltage $\pm 10\%$ of the nominal one
- Frequency : $\pm 1\%$ of the nominal one in a continuous way $\pm 2\%$ of the nominal one for a short period
- The harmonic distortion of the sum from the second to the fifth harmonics not more than 10 % of the total voltage as a real value between the conductors. A further distortion of 2% is accepted for the sum from the sixth to the thirtieth harmonics of the real total value between the conductors.
- With reference to the tension unbalance of the three-phase voltage, the inverted sequence component and the zero sequence component must not be more than 2% of the direct sequence component of the voltage
- The voltage pulses must not last more than 1,5 ms with an up/down time between 500 ms and 500 μ s and a peak value not higher than 200 % of the real value of the nominal tension.
- The electric feeding must not be interrupted or zeroed for more than 3 ms. Between two interruptions it must not take more than 1 s.
- The interruptions must not overcome 20 % of the tension peak for more than one cycle. Between two interruptions it must not take more than 1 s.

Chapter 4 DIMENSIONS AND MASS**4.1 DIMENSIONS AND MASS**

	AG092	AG092/1
LENGTH	330 mm	330 mm
WIDTH	745 mm	745 mm
HEIGHT	320 mm	330 mm
MASS	30 kg about	32 kg about

Chapter 5 OPERATOR INTERFACE**5.1 COMMANDS AND SIGNALS**

	COMMAND	DESCRIPTION
A1	MASTER SWITCH	Turns the shaker on and off. Also acts as an emergency switch.
A2	TIMER	Sets the test length according to the standard it refers to.
A3	CYLINDER HOLDER	Holds the cylinder containing the solution. The cylinder holder has a lever lock which locks the cylinder in position.
A4	PULLEY	By varying the distance between the sides the frequency of cycles per minute can be changed according to the standard it refers to.
A5	ELECTRIC MOTOR	Moves the cylinder holder.
A6	FEET	Allow the shaker to stand firmly on any kind of surface.
A7	SAFETY COVER	Prevents the operator from accessing the moving parts of the appliance (present only in model S160-01N).
A8	FRONT GUARD	Allows access to the internal parts of the appliance.

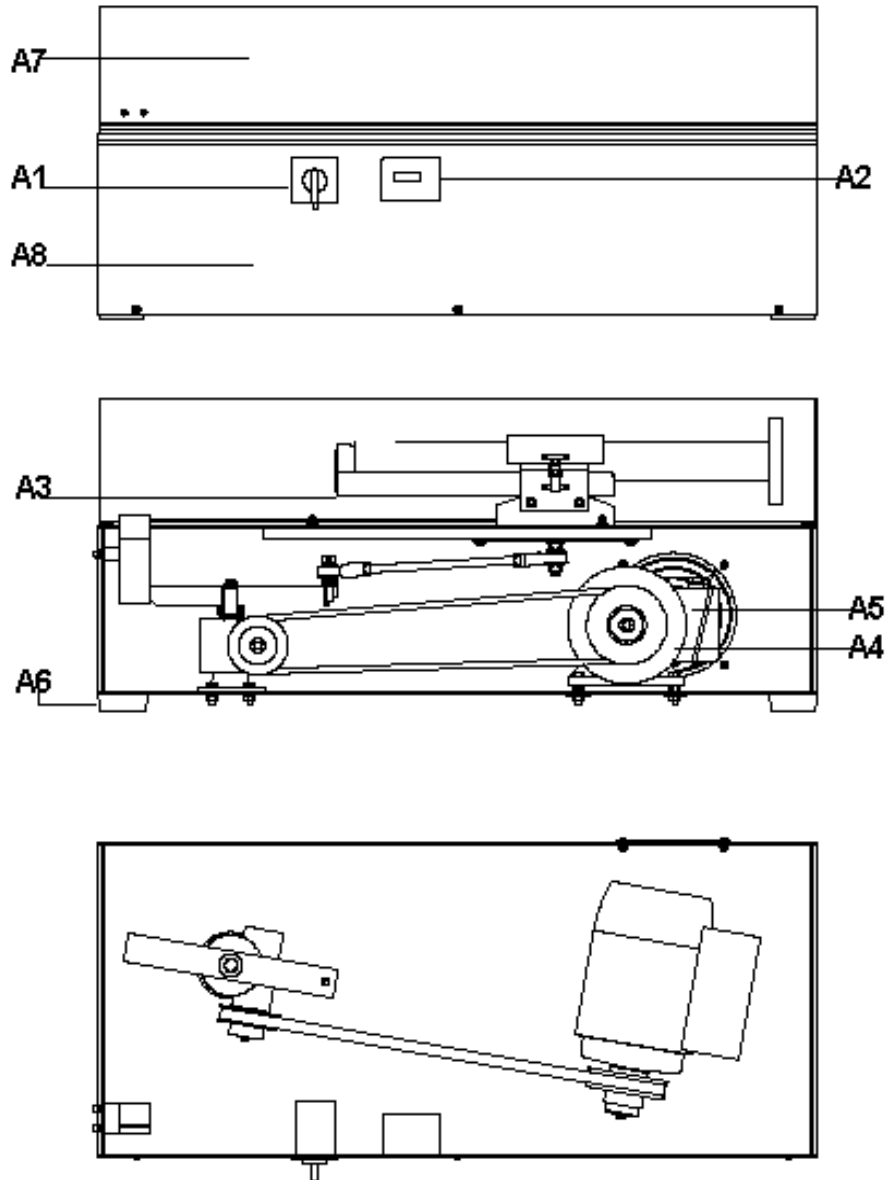

Chapter 6 USE



DANGER

Consult the charter DANGEROUS AREAS AND RESIDUAL RISKS before proceeding

6.1 SUGGESTIONS

Check the appliance has been installed correctly and that it has been placed in suitable working conditions before use; check its parts are not defective, damaged or worn. Carry out any necessary ordinary and extraordinary maintenance operations.

6.2 WORK PLACE

All operations must be carried out with the operator in front of the appliance.

6.3 SAMPLE POSITIONING

The sample, together with an appropriate solution, must be connected in the cylinder holder which is positioned horizontally on the A3 cylinder holder which has a lever lock to hold the cylinder in place.

Before placing the cylinder on the A3 cylinder holder close the open end of the cylinder with the appropriate rubber plug to prevent the solution from escaping.

6.4 SWITCHING ON THE APPLIANCE

Close (if equipped) the A7 safety cover and position the master switch to "I".

6.5 REGULATION OF STIRRING TIME

When the appliance is switched on, on the timer display the figures "00". "00" will appear.

Press the "sec" key once to set the second timing (keep the key pressed to make the count move forward more quickly).

Press the "min" key once to set the count one minute at a time (keep the key pressed to make the count move forward more quickly).

6.6 REGULATION OF STIRRING FREQUENCY

The appliance is set in the factory according to the standard requested by the client (EN, or alternatively ASTM)

If the user would like to follow an International Standard different from the one set, or if a different frequency is required, proceed as follows:

REGULATION OF STIRRING FREQUENCY

The shaker is equipped with a transmission belt with the use of a pulley with variable diameter applied on the motor. Such a pulley is equipped with a fixed side and a mobile side which can change the diameter of the actual pulley.

As in attachment when the distance between the two sides is 22 mm the setting for the ASTM test is reached, whilst with the distance of 20.5 mm the setting for the AFNOR-EN test is reached.

To vary the distance of the sides, proceed as follows:

- Ensure the appliance is connected to the electrical supply network.
- Remove the front guard (A8) by unscrewing the six fixing screws.
- Loosen the fixing screws of the motor positioned on the lower part of the machine, and move the motor so as to loosen the belt.
- Unscrew all dowels of the mobile side, but without removing it; then rotate it in such a way to vary the winding diameter of the pulley.
Note: screwing the side, the diameter increases and therefore the number of shakers increases. On the contrary, by unscrewing the side, the diameter and the number of shakers/per minute decrease.
- Fix the mobile side by screwing up the fixing mechanisms again.
- Make the belt tense (not excessively) by moving the motor in the initial position and screwing up the fixing screws again.
- Reposition the front guard (A8) and block it.
- Proceed for little steps, by performing little adjustments and checking immediately the variation of the shaking frequency. If needed, perform another adjustment.

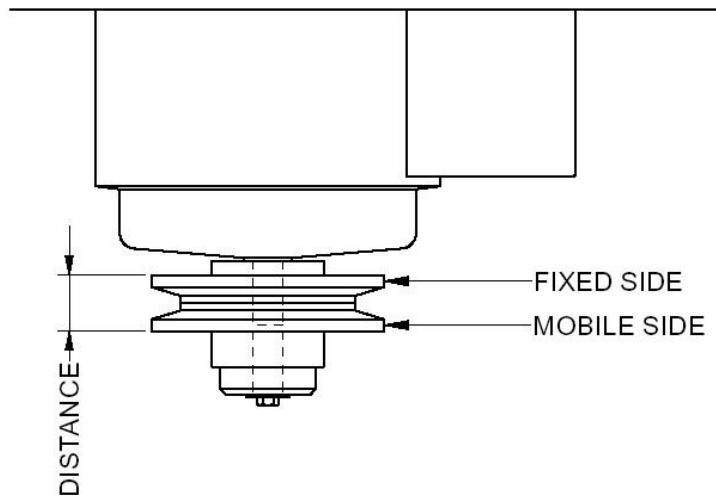
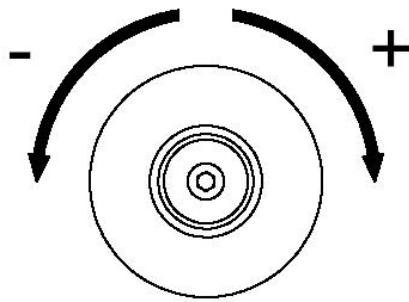

6.7 SWITCHING THE APPLIANCE ON

Press the “START/STOP” key on the timer to start the count.
The led on the timer and the display updates the time every second.

6.8 NORMAL STOP

The appliance stops automatically when the set time has passed.
The led on the timer switches off; an acoustic signal sounds; press any key to stop the ringing; the display will show the previously set time.

N.B.	To stop the test before the end of the count press the “START/STOP” key on the timer.
-------------	---

In this case on the timer the remaining time will be saved.
Before starting a new test correctly reset the test time; to completely set to zero switch the shaker off completely with the master switch (A1).

6.9 EMERGENCY STOP

In the case of emergency the test run can be immediately stopped by positioning the master switch (A1) on the “0”.

6.10 RESTART AFTER EMERGENCY STOP

	DANGER	Before restarting the machine detect and remove the cause of the emergency stop.
---	---------------	--

Simply turn the master switch (A1) to “I” to restart the machine, which will restore the normal functions to the shaker.

6.11 STOP COMMANDED BY SAFETY CIRCUIT (only for shaker S160-01N)

If the appliance has a test safety cover it can be suspended by specific intervention circuits in the case of anomalies. The shaker is equipped with the following safety device:

STOP COMMANDED BY THE MICRO OF THE OPENING OF THE SAFETY COVER

The safety cover (A7) is equipped with a micro operator protection switch, in order to avoid access to the moving mechanisms during the test. When the guard is opened the micro removes the current from the electric motor (A5) and stops it functioning. To reset the shaker to its normal function the safety cover must be closed.

When the safety cover is opened the timer, if not interrupted, will continue its count until it tips over; when the guard is closed again the shaker will start to work normally again.

This is however not a correct procedure

To correctly open the safety cover, proceed as follows: after switching the shaker on, press the START/STOP button to stop both the shaker from working and the timer; at this point open the safety cover to intervene where necessary.

To reactivate the functions close the guard again and press the START/STOP key again; the count will start from where it was stopped.

6.12 SWITCHING OFF

Position the master switch to "0".

6.13 TEST START UP

Before using the appliance regularly check it is working correctly by carrying out at least one complete empty cycle according to the previous instructions.

Should there be any problem consult the chapter "DIAGNOSTICS".

If the instructions in this manual do not provide the solution to the problem, contact Sales Assistance.

Chapter 7 MANTEINANCE

	WARNING DANGER	Consult DANGEROUS PARTS AND RESIDUAL RISKS before proceeding. All the maintenance operations must be carried out with the machine turned off and unplugged from the knife switch. Any kind of maintenance operations concerning the components of the machine and of the electric components, even those that may seem very simple, must be carried by skilled operators instructed about the purposes the machine is made for. Only original spare parts are allowed. The Manufacturer assumes no liability in the event that non – original parts are used.
---	---------------------------	---

7.1 MANUTENZIONE ORDINARY MANTAINANCE

	DANGER WARNING	Do not perform maintenance – interventions on the machine which have not been quoted and described in this instructions manual without first contacting the manufacturer. Periodically clean all machine parts and oil the unpainted parts in order to preserve the machine and its efficiency. Avoid the use of solvents which damage paint and parts in synthetic material.
---	---------------------------	---

7.2	PERIODICAL INSPECTIONS
------------	-------------------------------

Punctually and correctly make the periodical inspections shown below in order to prevent possible damage or malfunctioning.

Such an inspection must be done only when the machine is equipped with a safety cover.

OPERATION	SECURITY SWITCH OPERATION
PROCEDURE	With the appliance in operation open the safety cover and check the appliance stops. Should this not occur contact Technical Service Assistance.
FREQUENCY	AFTER 50 HOURS OF WORK OR AFTER A LONG PERIOD OF DISUSE

7.3	PERIODICAL OPERATIONS
------------	------------------------------

Punctually and correctly carry out the periodical operations shown below in order to prevent possible damage or malfunctioning.

OPERATION	TRANSMISSION BELT CHECK
PROCEDURE	Remove the guard with the six fixing screws; turn the screws which fix the motor and move the motor back until the optimum chain tension is obtained. Should the tension be corrected frequently the belt must be changed.
PRECAUTIONS	Before the operation turn the master switch (A1) to "0" and physically disconnect the appliance from the electrical supply.
FREQUENCY	EVERY SIX MONTHS OF USE

7.5	SPECIAL MAINTENANCE
------------	----------------------------

For extraordinary maintenance operations (repairs, substitutions and any other operation not described in this manual), directly refer to the Manufacturer.

Chapter 8	DIAGNOSIS
------------------	------------------

This chapter introduces and discusses simple problems which could arise when the machine is working.

	WARNING DANGER	All the maintenance procedures, check and control, as well as all the repair operations on parts of the machine or the electrical system, must be carried out by the appropriately qualified, professional personnel.
---	---------------------------	---

INCONVENIENTE	POSSIBLE CAUSE	REMEDY
The timer does not turn on after pressing the master switch	No supply	Check the plug has been inserted correctly
	Damaged timer	Contact Technical Service Assistance
	Broken electrical supply	
The appliance does not work after starting the test	Incorrect closure of the safety cover (if supplied)	Close the safety cover
	Broken motor	Contact Technical Service Assistance
	Damaged timer	Contact Technical Service Assistance
When opening the safety cover the shaker does not stop	Damaged electrical supply	Contact Technical Service Assistance

Chapter 9 INACTIVITY

Ensure all machine parts are in safe working order before operating it again should the machine be inactive for a long period of time. When in doubt contact the Manufacturer.

Chapter 10 DECOMMISSIONING THE MACHINE

Should it be decided that the machine is to be no longer used, proceed as follows:

- Disconnect the electrical supply network by removing the connecting cable therefore making it unusable.
- Make the potential sources of danger harmless, such as sharp or protruding parts.
- Dismantle the machine; divide it into similar parts and dispose of according to the standards in force.

Recycling notice for the disposal of electrical and electronic devices



This symbol, shown on the device or on the package and/or the documentation, suggests that the device should not be disposed together with other home garbage at the end of its life cycle.

To avoid further environment, or health-care damage, caused by the unsuitable disposal of garbage, the user should separate this device from other different types of garbage and recycle it in responsibly to avoid the reuse of material resources. Users must take care at the disposal of the equipment by taking it to the nearest recycling site for appropriate recycling treatment for electrical and electronic devices. Gathering and Recycling deplete devices allow the preservation of natural resources and grant them the adequate treatment by respecting health and environment.

For further information on your local recycling site please contact your local council or city waste treatment department.

The developer, as producer of electrical and electronic devices, will provide to finance the recycling and treatment services for deplete devices that will come back through these recycling sites, according to the local statement.

IMPACT
IMPACT
IMPACT

